

Maritime Book & Claim

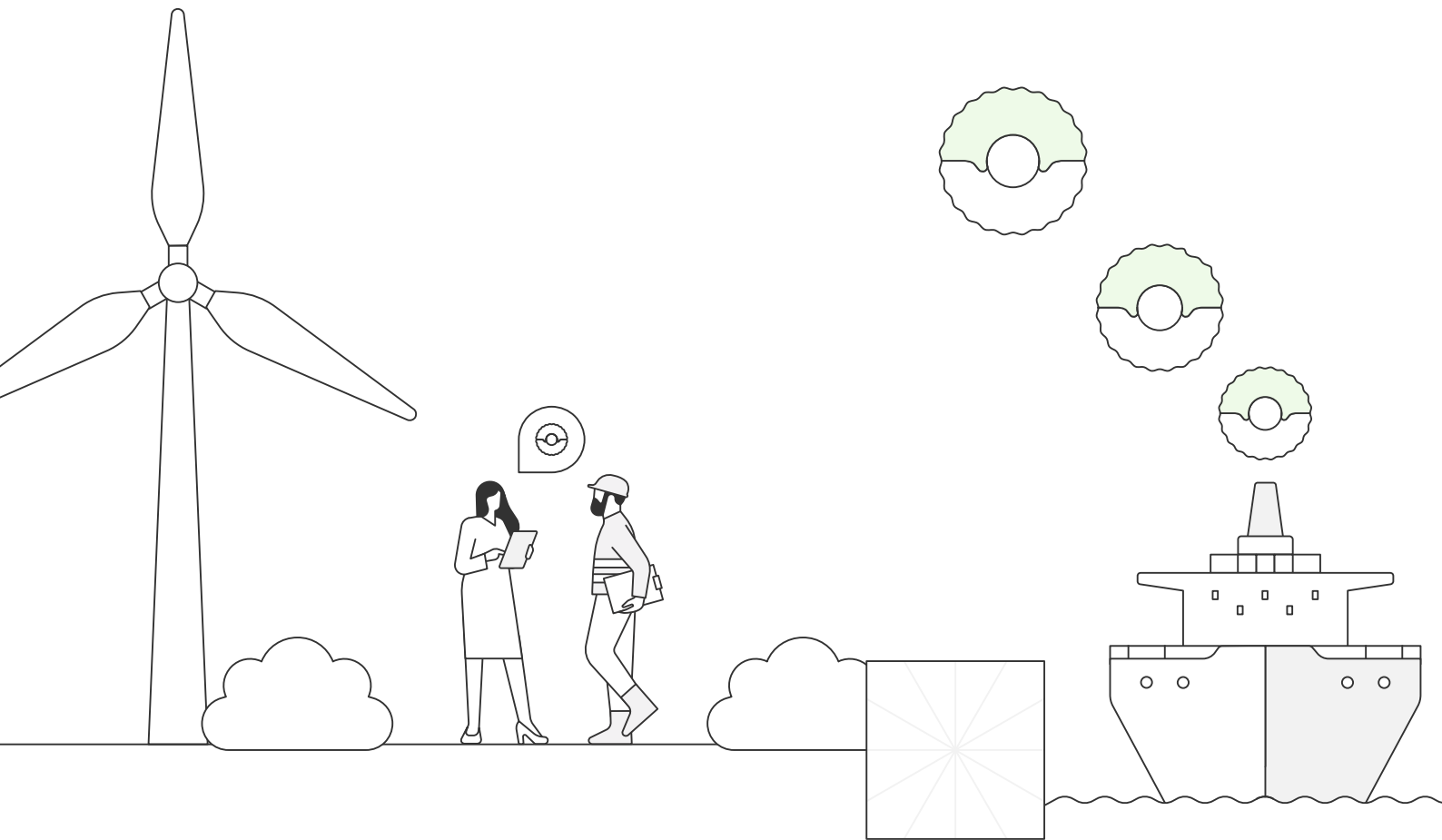

Design decisions and justifications

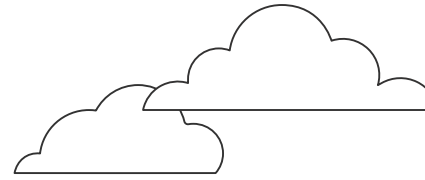

Mærsk Mc-Kinney Møller Center
for Zero Carbon Shipping



Project funding received from



Contents

1. Introduction	3
1.1 Designing our Book & Claim system.....	3
1.2 Unique design features of our Book & Claim system.....	4
1.3 Emissions overview.....	5
2. Chain of custody	9
2.1 How participants measure or calculate emissions	9
2.1.1 WTT emissions.....	9
2.1.2 TTW emissions.....	11
2.1.3 WTW emissions & energy consumption calculations	12
2.1.4 Emissions excluded from our Book & Claim system	12
2.2 How participants collect transport activity data.....	14
2.2.1 Cargo data.....	14
2.2.2 Distance Data	17
2.3 Who submits data.....	17
2.4 How often data is submitted	18
2.5 System unit & tokens.....	18
2.5.1 System units.....	19
2.5.2 Token information	21
Box 1: Additionality	23
3. Market rules	26
3.1 Participants.....	26
3.2 Processes.....	27
3.2.1 Booking.....	29
3.2.2 Allocating	30
3.2.3 Claiming	33
3.2.4 Passing.....	33
3.2.5 Swapping	33
3.2.6 Skipping.....	34
3.3 Time allowed for processes	36
3.4 Segmentation.....	37
4. IT infrastructure	39
4.1 Functionality and elements	39
4.2 Key features	40
5. Governance	42
5.1 Principles.....	43
5.2 Structure.....	44
5.3 Verification framework.....	45
Box 2: Double counting	49
6. System acceptance	52
6.1 Regulators.....	52
6.2 Accounting and reporting.....	54
7. Conclusion	58
Abbreviations.....	60
System-related definitions.....	61
Maritime-related definitions.....	64
Annex 1	66



1. Introduction

The purpose of this paper is to describe and justify the decisions we took whilst designing our Maritime Book & Claim system.

The content of this paper is centered around six sections, described below.

- **Introduction:** A description of our approach to designing this system.
- **Chain of custody:** Description of how our system will collect emission and transport service data.
- **Market rules:** Overview of who will be able to use our system and its functionality.
- **IT infrastructure:** Initial thoughts on what will be required for this system’s IT infrastructure.
- **Governance:** Description of the governance framework for this system.
- **System acceptance:** Analysis of our system’s compatibility with regulatory and accounting frameworks.

In addition to this report, there is a '[Maritime Book & Claim System Overview](#)' paper that contains a description of Book & Claim, the value it brings to the maritime industry, and a high-level overview of how this system works. A manual providing detailed instructions for using this system is under development to prepare for the pilot.

The content outlined in this paper is an important first step towards developing a maritime-focused Book & Claim system, but it is not the final step. Learnings and insights gained prior to and during the pilot will be incorporated in the system design. Industry-wide engagement and collaboration is needed to make Book & Claim a reality in the maritime industry.

1.1 Designing our Book & Claim system

The first stage of our Book & Claim project involved creating a design for our system based on extensive dialogue with different stakeholders from across the maritime industry. The design of our Book & Claim system was centered around detailing three fundamental components. These components consist of the building blocks that establish how a system would work, the market that the system would create, and how external authorities perceive the system (see Figure 1). This initial stage of our project focused on developing the building blocks and understanding system acceptance.

Figure 1: Components of a Book & Claim system.

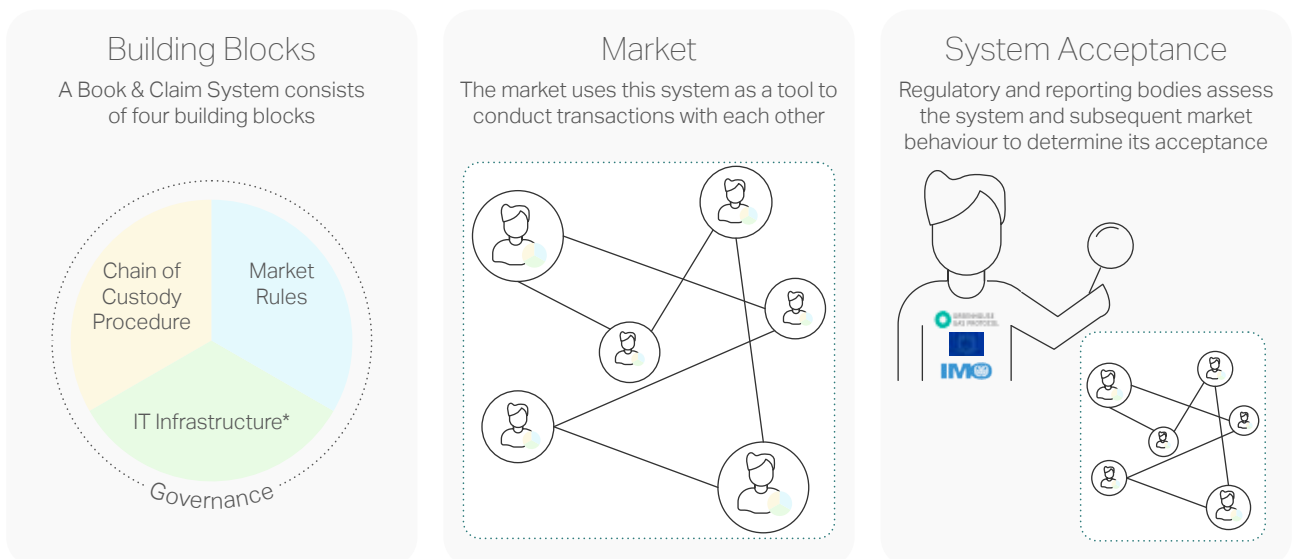

The four building blocks that comprise this system are:

- **Chain of custody procedures:** This block details the information needed to create a chain of custody between greenhouse gas (GHG) emissions and transport activity. This includes how information is gathered (i.e., how to measure emissions and transport service), the frequency at which these measurements are used in the system, and the system unit used.
- **Market rules:** This block articulates the rules around who can participate in the system, the actions taken with tokens, and the time allowed for these actions.
- **IT infrastructure:** This building block describes the key features needed for the system's IT infrastructure.
- **Governance:** This building block outlines the principles and procedures for verifying and validating data and transactions, and the overall governance structure.

Feedback sessions and design work can never answer all questions about how a Book & Claim system will work. Once fully functioning, this system will be used by participants in different manners. A key component of a Book & Claim system design is understanding what kind of market and behavior the system drives. However, this can only be fully understood when the system is in the hands of users. As a result, we will be conducting a pilot to test the system and understand the behavior it drives.

The final key consideration for designing a Book & Claim system is system acceptance. Book & Claim does not exist in a vacuum, and authorities across the maritime industry will take a view on whether this system is valid and can be used for official purposes. These authorities include organizations like the International Maritime Organization (IMO), the European Union (EU), and the Greenhouse Gas Protocol (GHG-P). When designing a Book & Claim system, any gaps and compatibility issues with current and expected frameworks must be understood. While this Book & Claim is a voluntary system in its current state, compatibility with regulatory frameworks could further enhance its credibility and accelerate its uptake by the maritime industry.

1.2 Unique design features of our Book & Claim system

There is no off-the-shelf blueprint for building a Book & Claim system. There are existing Book & Claim systems used in the electricity sector and developments in the aviation sector. The organizations behind these systems have all taken slightly different approaches to designing their Book & Claims. However, regardless of the approach taken, a key tenet of a well-designed system is credibility. The design of our Book & Claim is centered around building the most credible system to exchange GHG emissions. At a high level, the four key features of this design are that it is shipping focused, based on primary data, provides emission transparency along the supply chain, and exchanges emissions through swaps. All four features were chosen to enhance credibility. The rationale for these choices is explained in this section.

All emissions included in our system will derive from a ship rendering a transport service and can only be transferred within the maritime value chain. As our system will use energy intensity per megajoule (MJ), it could be argued that the starting point for the system should be fuel suppliers. Such a system would involve trading fuel characteristics prior to consumption. However, our approach involves trading fuel characteristics after consumption. Making the consumer rather than the producer of fuel the starting point in our Book & Claim will establish a clear link between the fuel and a transport service. There are a variety of low-emission alternative fuels that will be required to decarbonize shipping, and there will be significant competition between industries for these fuels. Choosing to begin our system downstream of fuel producers incentivizes using these fuels in maritime transport, and also funnels capital back to owner/operators investing in dual-fuel or new-fuel vessels. There is still a clear link to fuel suppliers, who will be key stakeholders in our Book & Claim system as providers of certified fuel.

Our Book & Claim design is based entirely on primary data. All information collected for emissions and transport services must be collected from the ship during the actual voyage. Much of this data is already collected today for ships over 5,000 gross tonnages under the EU Monitoring, Reporting, and



Verification (MRV) Regulation¹ and IMO Data Collection System² (DCS) databases. Many of the procedures and processes to gather this information are well established.

Our reason for using primary data is that it is the most accurate way to calculate emissions. The GHG-P states that companies should use the most accurate calculation approach available for emission reporting.³ Many organizations calculate their scope 3 shipping emissions using secondary data, including default values based on industry-average data. However, in its scope 3 guidance, GHG-P introduced primary data for scope 3. With the same spirit, the Global Logistics Emissions Council (GLEC) framework highlights that primary data is more likely to represent actual emissions associated with specific activities compared to secondary data.⁴ Furthermore, a more accurate understanding of emissions resulting from specific activities allows companies to better evaluate the cost and benefit of actions that reduce emissions.

Our Book & Claim system also facilitates the passing of primary data along the supply chain to provide transparency (see section 3.2.4 for more details on passing). Lack of transparency is a commonly cited hurdle for reducing companies' supply chain emissions.⁵ There is no fully functional and widely accepted infrastructure for sharing environmental data along the maritime supply chain. Our Book & Claim system will require shipowners or ship operators to upload the voyage and emission-related data and pass this data down the supply chain. As a result, participants of our Book & Claim system will receive the precise information related to their transport activity and corresponding emissions.

Our system will exchange emissions via a swap. When trading a token, a participant must accept the same number of tokens in return. This means that, to claim a certain emission level, a participant must find a counterparty willing to accept their emissions. Swapping keeps total emissions within a system constant and removes the risk of leakage. Participants can only swap for the GHG emissions they are directly (scope 1) or indirectly (scope 3) responsible for through

energy consumption. Thereby, every tonne of GHG emissions from participants within the system is traceable and remains on someone's account. Since all GHG emission profiles that can be exchanged within the system ultimately rest on real action, i.e., fuel choices, vessel technology, and the efficient use of fuels, participants cannot achieve a GHG emission profile that is not based on 'reality'. This will prevent participants artificially increasing their GHG emission profiles without limitation by taking other participants' emissions in return for payment.

The alternative to using swaps is transferring emission reductions. Emission reductions are the difference between actual emissions and a counter-factual baseline. A counter-factual baseline is the emissions that would have resulted from using a different fuel type. These types of transfers can be problematic. The selling participant has no information about the type of fuel used by the receiving participant and, therefore, may use an incorrect counter-factual baseline. The receiving participant has no information on the counter-factual baseline used by the selling party. After a transfer of an emission reduction, both parties have little information regarding their final emission profiles.

1.3 Emissions overview

Our Book & Claim system will include scope 1 and 3 emissions on a well-to-wake (WTW) basis using CO₂ equivalents (CO₂eq). This section describes scope 1 and 3 emissions, the difficulties the maritime industry has in classifying them, what well-to-wake means, and how other emissions are included with CO₂.

GHG accounting principles provide guidance and standards for companies calculating and reporting their GHG emissions. The mostly commonly used framework, the GHG-P, categorizes the emissions into three groups based on their relevance to the company:⁵

- **Scope 1:** Direct GHG emissions from sources owned or controlled by the company.
 - Includes direct emissions from assets owned or controlled by the reporting company, including the

1 [REGULATION \(EU\) 2015/757 OF THE EUROPEAN PARLIAMENT AND OF THE COUNCIL](#), European Union, 2015

2 [IMO Data Collection System \(DCS\)](#), International Maritime Organization

3 [The Greenhouse Gas Protocol: A Corporate Accounting and Reporting Standard \(Revised Edition\)](#), Greenhouse Gas Protocol

4 [What is the GLEC Framework](#), Smart Freight Centre

5 [Net-Zero Challenge: The supply chain opportunity](#), World Economic Forum in collaboration with Boston Consulting Group, 2021



combustion of solid or liquid fuels purchased to produce energy, heat, or steam.

- Reporting on these emissions is mandatory under GHG-P.
- **Scope 2:** Indirect GHG emissions from producing electricity a company purchases and uses.
 - Reporting on these emissions is mandatory under GHG-P.
- **Scope 3:** Other indirect GHG emissions arising from company activities but from sources not owned or controlled by the company.
 - This scope includes 15 categories, of which three are most relevant for the maritime industry - category 3 (emissions related to the production of fuels and energy purchased and consumed by the reporting company that are not included in scope 1 or 2), category 4 (emissions related to upstream transportation and distribution), and category 9 (emissions related to downstream transportation and distribution).
 - Reporting on these emissions is voluntary under GHG-P.

GHG-P details the principles behind these scopes, but the exact definitions vary across industries based on the nature of their business. Several industries have specific guidance based on these principles. For shipping, the most relevant guidelines are the Global Logistics Emissions Council Framework (GLEC Framework). This framework provides guidance for scopes 1 and 3 for customers of logistic services.

- Scope 1 is the tank-to-wake emissions from fuels burned in the reporting company's owned or controlled vehicles and logistics sites.
- Scope 3 includes the well-to-tank emissions for the production and distribution of fuels burned in scope 1 (category 3), WTW emissions from upstream transportation and distribution (category 4), and WTW emissions from downstream transportation and distribution (category 9).

Despite the detailed guidance on what to count as scope 1 and 3 emissions, the ownership and responsibility of scope 1 and 3 are not clearly defined in the maritime industry. This ambiguity is driven by the complex operating models, different charter parties, and organization types found in the maritime industry.

The key criterium for scope 1 emissions is that they arise from fuels burned in the reporting companies' owned or controlled vehicles and logistics sites. In shipping, a ship's ownership and control are often separated and belong to different parties. Some companies own, operate, and have control of their ships. However, some organizations act solely as either owners or operators. The phrasing 'owned or controlled' in defining scope 1 emissions allows flexibility in interpreting which party is responsible – and different organizations interpret this differently.

Another issue is defining what control means for emissions. As emissions are linked to fuel, an argument can be made that the party responsible for purchasing the fuel has control over the emissions. However, the party responsible for purchasing fuel varies depending on the charter party. For example, the shipowner is responsible for purchasing fuel in a voyage charter, but the charterer is responsible in time and bareboat charters.

Finally, the shipping companies and customers often belong to larger organizations, which streamline their GHG accounting principles across all functions. In such cases, the decisions to report scope 1 and 3 emissions are influenced by the nature of the overall parent organization rather than maritime-specific considerations.

Our conversations with industry stakeholders while developing our Book & Claim system confirmed the lack of consensus on scope 1 ownership in the maritime industry. Based on this, our Book & Claim system will take a flexible approach that accommodates the diversity of views on scope 1 ownership. Our Book & Claim system will incorporate any industry-wide standards or practices in emission accounting for the maritime industry once they are available.

In the absence of an industry-wide standards and practices in emission accounting for the maritime industry, our system will apply the following principles related to scope 1 and 3 emissions.

- For every transport service rendered, the emissions from such transport service will be reported by only one entity as scope 1.
- Multiple entities are allowed to report such emissions as scope 3.

In practice, the system will accept shipowners and



charterers as scope 1 or scope 3 owners, provided the above principles are upheld. The system will require the parties involved in the transport activity to identify themselves and agree on their respective accountabilities before registering the transport service with the system and generating any tokens. This is further discussed in section 3.2.1.

The focus of the shipping industry is the emissions associated with the fuel used to render the transport services. The IMO categorizes such emissions⁶ as:

- **Well-to-tank (WTT):** Upstream emissions from primary production to carriage of the fuel in a ship's tank.
- **Tank-to-wake (TTW):** Downstream emissions from the ship's fuel tank to the exhaust.
- **Well-to-wake (WTW):** The combination of the GHG emission for the WTT and the TTW emissions.

IMO's technical guidelines and emission-reduction targets for the shipping industry are based on TTW and WTW emissions. These guidelines and targets do not include any discussion around emission scopes. This allows shipping companies to comply with IMO regulations while maintaining a degree of freedom regarding compliance with emission accounting standards.

As with many aspects of emissions accounting, no industry-wide standard exists on whether to use TTW or WTW. Different regulations use WTW or TTW to suit their distinctive needs. The IMO uses TTW emissions for their Carbon Intensity Indicator (CII) and Energy Efficiency Existing Ship Index (EEXI) measures,⁷ while Renewable Energy Directive II⁸ and FuelEU Maritime⁹ adopt a WTW methodology. Science Based Targets (SBTi) in Science Based Target Setting for the Maritime Transport Sector version 1.0 choose to base their targets and decarbonization trajectory on WTW emissions without a firm rule on the relationship between scope 1 and 3 and WTW emissions.¹⁰

Our Book & Claim system is based on WTW emissions.

Using WTW emissions enables the assessment of the complete decarbonization impact from fuels, from production to consumption. The decarbonization impact of several alternative fuels is mainly related to WTT emissions, and evaluating fuels based only on TTW emissions offers an incomplete picture. It risks discounting the decarbonization benefits of alternative fuels and incentivizing investments into fuels which are not optimal from a lifecycle perspective.¹¹

Emissions can generally be categorized into GHGs and air pollutants, with GHGs having a global impact on the climate, and air pollutants impacting human health and/or the environment. As research and regulatory guidance on GHG and air pollutants are ongoing, our Book & Claim system will incorporate GHG in compliance with the draft IMO LCA Guidelines and the recently approved FuelEU Maritime framework. Therefore, the impacts of methane (CH₄) and nitrous oxide (N₂O) will be calculated in terms of CO₂eq based on their 100-year global warming potentials¹². As with many things in this system, these calculations will be updated to reflect new regulations or guidance.



⁶ [Guidelines on life cycle GHG intensity of marine fuels \(LCA Guidelines\)](#), International Maritime Organization

⁷ [EEXI and CII - ship carbon intensity and rating system](#), International Maritime Organization

⁸ [DIRECTIVE \(EU\) 2018/2001 OF THE EUROPEAN PARLIAMENT AND OF THE COUNCIL](#), European Union, 2018

⁹ [Special Report: Global Warming of 1.5°C](#), Intergovernmental Panel on Climate Change

¹⁰ [Science based target setting for the maritime transport sector](#), Science Based Targets, 2022

¹¹ [Creating a Global Fuel Lifecycle Methodology](#), Mærsk Mc-Kinney Møller Center for Zero Carbon Shipping, 2023

¹² [ANNEXES to the Proposal for a Regulation of the European Parliament and of the Council on the use of renewable and low-carbon fuels in maritime transport and amending Directive 2009/16/EC](#), European Union, 2021



02

Chain of custody

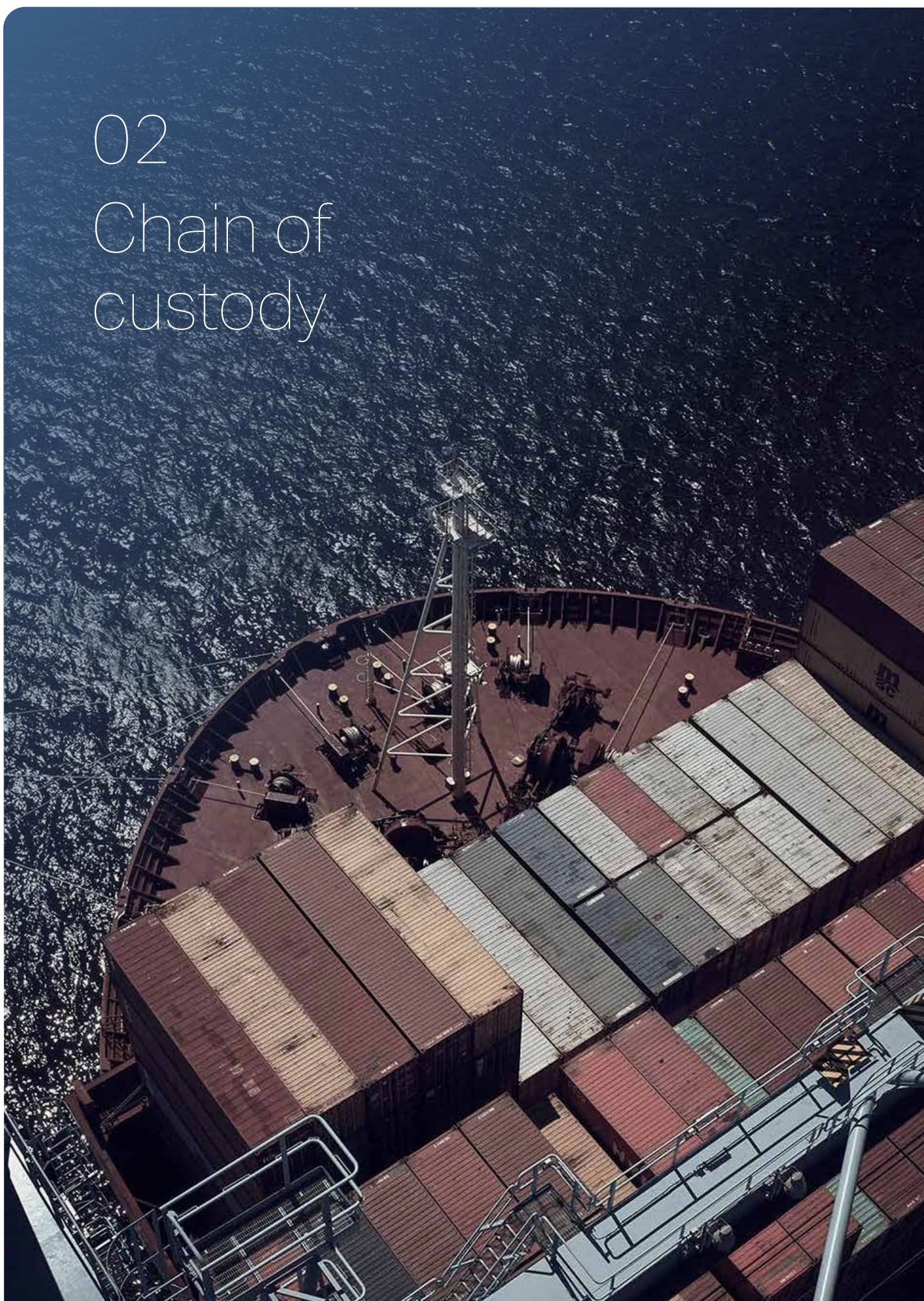

2. Chain of custody

This section discusses the different data required to establish a chain of custody for maritime transport-related emissions. The complete list of data requirements will be included in the manual.

This system will track emissions and transport activity-related data along the physical supply chain. The system will collect emission data (either directly or via based on fuel consumption), amount of energy consumed during transport, data related to cargo or passengers transported, and the distance traveled during transport. While certain information can be directly obtained, some data requires the participant to measure or calculate based on a system-approved procedure. The methodology to measure or calculate the required data is outlined in this section, along with how this data is translated into tokens that can be used to exchange emissions. Participants can also include additional information in tokens that can be shared with counterparts to meet specific preferences of participants. The collection of data related to the identity of participants and the parties along the supply chain is discussed in section 3.

2.1 How participants measure or calculate emissions

This system is based on WTW emissions. Credible information is required for both WTT emissions from fuel production and distribution, and TTW emissions caused by fuel consumption on ships. This section outlines how the system will acquire information on WTT emissions through certificates or other credible statements, and information on TTW emissions through primary data. As improved methodologies for measuring or calculating emission-related data are developed, they may be incorporated in the system.

2.1.1 WTT emissions

The starting point for determining GHG emission intensities will be the WTT GHG emission profiles of the fuels used by the ship. Participants must safeguard and provide evidence that they own the rights to all emission categories (according to the GHG-P). If, for example, the respective scope 3 emission profile for a fuel has been sold to a third party, the participant will only be able to use the remaining, higher emission

profile, and only under the precondition that they can substantiate the effective profile through proper documentation.

These are the following three options to determine WTT emission profiles:

1. Based on recognized frameworks

For some alternative fuels, voluntary frameworks are available for determining WTT emissions, which are continuously being developed and increased in scope by different entities. Fuel producers typically mandate independent technical inspection companies accepted by the framework provider to assess fuel production according to the principles defined by the respective framework. Based on the results, a certificate is issued, which is valid for a limited time, stating – among other details – the production-related GHG emission footprint of the alternative fuel in CO₂eq. The system will accept certificates issued according to the following frameworks as reliable sources of information:

- **REDcert:** Offers national (German) and European certifications with REDcert-DE and REDcert-EU, respectively. Within the fuel segment, the framework covers the whole upstream production process with a focus on bio-fuels.
- **ISCC Sustainable Marine Fuel Certification:** As one of the world's largest certification frameworks, ISCC covers a broad range of sectors ranging from energy to industrials and food. Within the energy sector, the framework currently covers bio-fuels, recycled carbon fuels, and renewable fuels of non-biological origin. By complying with various international standards, e.g., the EU Renewable Energy Directive (RED) and the Fuel Quality Directive (FQD), ISCC targets global acceptance.
- **RSB:** Like the ISCC, RSB is aiming at global acceptance with its certification frameworks that comprise multiple sectors, including energy and shipping. Within the latter, RSB covers bio-fuels, alternative fuels of non-biological origin, and certain advanced fuels made from end-of-life products. Regarding regional coverage, RSB offers a global certification scheme (RSB Global Fuel) and a specific one incorporating principles of the EU Renewable Energy Directive (RSB EU RED Fuel Certification).



The Intersessional Working Group on Reduction of GHG Emissions from Ships (ISWG-GHG) is currently developing the IMO lifecycle GHG carbon intensity guidelines to encourage the uptake of alternative low-carbon and zero-carbon fuels. The framework will also apply to conventional fuel production routes. The envisaged lifecycle assessment method will assess GHG emissions with a WTW perspective. Upon availability, the system will accept certificates issued based on this framework.

2. Based on proprietary assessments by fuel producers

In cases where a fuel is not certified by any of the accepted frameworks listed above, which is currently the case for almost all conventional marine fuels, the system allows participants to fall back to WTT GHG emission profiles derived from proprietary lifecycle assessments made by fuel producers. Nevertheless, the results of such non-standard assessments will only be accepted if a credible independent entity has validated the process.

3. Based on fuel emission factors

The last option should only be applied when participants can provide evidence that none of the options listed above are available. In this case, participants can use fuel emission factors¹³ for translating fuel or energy quantities into GHG emissions, as provided by the FuelEU Maritime framework. The fuel emission factors may be updated if a global standard of fuel emission factors is developed by the IMO. This last option does not apply to alternative fuels for which recognized frameworks or

proprietary assessments are fundamentally available. Furthermore, if a participant decides to use this option, they will only be allowed to apply fuel emission factors for the conventional equivalent of the respective fuel.

The above methodologies are applied to single fuels only. Blends of different fuels are rated based on certificates carried by their components. Therefore, tokens can only be issued for blends if each part has a valid certificate, according to one of the options listed above.

The system will require participants to use the most accurate and credible method available for each fuel, with certificates issued according to recognized frameworks being the preferred choice. Falling back to proprietary assessments must be explained, and all relevant documentation describing the methods disclosed. The same applies to basing estimates on accepted industry averages. For guidance, our Book & Claim platform will release and maintain detailed instructions listing accepted ways to determine WTW GHG profiles, ordered by preference. Independent of the chosen option, the relevant WTT GHG emissions, expressed in CO₂eq, will need to be harmonized to a 100-year global warming potential and the GHG coverage (CO₂, CH₄ and N₂O), in line with the FuelEU Maritime provisions.

Regarding the verification of the data and related processes, Table 1 shows the verification activities, depending on the option chosen by the shipowner or operator to measure WTT emissions. The overall verification framework is outlined in section 5.3.

Table 1: Verification of WTT emissions.

Recognized Frameworks	Verify the authenticity and status of the certificate using the available databases or procedures defined by the standard owner (e.g., REDcert, RSB, ISSC). If the certificate's status is suspended or revoked, the shipowner or operator cannot use a proprietary method or documentation from a fuel producer to calculate emission intensity. Instead, they must use fuel emission factors from approved sources.
Proprietary assessments	Verify that the fuel producer's proprietary method considers all the emissions included in the system (CO ₂ , CH ₄ , and N ₂ O), translates their emissions to CO ₂ eq using GWP 100, and includes relevant sustainability attributes of the feedstock and production process. If there is a material deviation from the system methodology, the shipowner or operator must use fuel emission factors from approved sources.
Emission factors	Verify that the shipowner or operator uses the appropriate fuel emission factors for each fuel type, properly applying the procedures and assumptions established in the methodology. Also, the verifier should assess the consistency in applying the same fuel emission factors through any segment, vessel type, and voyages, unless there is a reasonable and technically supported reason to use a different methodology.

¹³ Fuel emission factor in the Maritime Book & Claim describes the amount of GHG emission released for a unit of energy of fuel consumed. In GLEC framework, it is referred as fuel emission factor. In FuelEU, it is referred as emission factors. In RSB Book and Claim Manual, it is referred as GHG emission factor. In Fourth IMO GHG Study, it is referred as CO₂ emission factors.



2.1.2 TTW emissions

In addition to the selected primary fuel, emissions are directly related to the main onboard energy storage and conversion technologies. Up to 90% of the total onboard energy demand is for propulsion and is typically supplied by the main energy converter(s), contributing the majority of a vessel's emissions. Internal combustion engines are predominantly used onboard vessels today, with other energy converters, such as fuel cells, potentially becoming viable alternatives in the future.

While most onboard emissions are from the fuel combustion in the engine, there are other potential sources from normal operations. For example, exhaust gas and slip from energy converters during normal running conditions are also sources of onboard emissions.

Measuring fuel consumption is already done regularly as part of normal vessel operations. There are different measurement methods, with the most common one being based on manually sounding fuel tanks to determine the quantity of fuel stored onboard. Tank level measurement sensors are also available to avoid manual sounding. An alternative and more accurate way of measuring fuel consumption is using flow meters (e.g., Coriolis flow meter) that measure the fuel moving through the fuel supply system to the engine. However, fuel tank level sensors and flow meters can be expensive.

Shipowners (Document of Compliance holders) are required to measure and report fuel consumption and CO₂ emissions as part of the Monitoring, Reporting and Verification (MRV) system for the EU and UK, as well as the Data Collection System (DCS) for the IMO. Four methods for determining CO₂ emissions are outlined within the EU MRV regulation:¹⁴

- a. Bunker fuel delivery note (BDN) and periodic stock takes of fuel tanks
- b. Bunker fuel tank monitoring on board
- c. Flow meters for applicable combustion processes
- d. Direct CO₂ emissions measurements.

Emission calculation methods a, b, and c are based on fuel consumption measurements, requiring conversion factors (the fuel emission factors in this case), whereas method d directly measures CO₂ emissions by multiplying the CO₂ concentration of the exhaust gas with the exhaust gas flow.

In our Book & Claim system, TTW emissions will be determined based on the quantity of fuel consumed or via direct emission measurements. This system will accept all methods for calculating TTW emissions outlined in the EU MRV regulation.

The verifier shall validate the process implemented to ensure compliance with the methodology presented above and then verify the calculation made for selected voyages.¹⁵ This varies depending on the verification activity, as shown in Table 2.

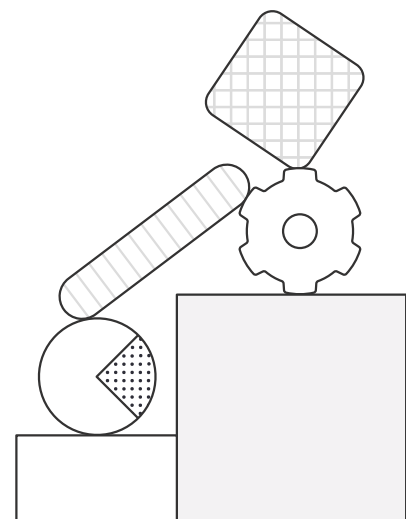

¹⁴ [REGULATION \(EU\) 2015/757 OF THE EUROPEAN PARLIAMENT AND OF THE COUNCIL](#), European Union, 2015

¹⁵ For the purpose of the Book & Claim system, a voyage is defined in section 2.4.



Table 2: Verification of TTW emissions.

	Initial Audit	Surveillance Audit	Inter-audit verification
Process	Validate that the process to calculate TTW emission follows the rules established in the system methodology.	Verify if there is a substantial change in the processes (e.g., the way fuels are measured) that may impact the TTW emissions per voyage.	-
Data	Verify the calculation of TTW emissions for the first batch of voyages included in the Book & Claim system.	Verify the calculation used in a sample of the voyages submitted to the Book & Claim system since the last audit. ¹⁶	Cross-check fuel consumption submitted ¹⁷ against historical and benchmark values (e.g., automatic identification system - AIS) or route modeling software), considering specific shipping segments, vessel, and voyage characteristics. ¹⁸

2.1.3 WTW emissions & energy consumption calculations

WTW emissions are the sum of WTT and TTW emissions. This system calculates WTT emissions by multiplying the quantity of fuel consumed by the WTT fuel emission factor. This system calculates TTW emissions either by multiplying the quantity of fuel consumed by the TTW fuel emission factor, or by using directly measured TTW emissions.

In FuelEU Maritime, energy consumption is calculated by multiplying the fuel consumed by its lower heating value (LHV), usually expressed in kJ/kg or MJ/kg. For fossil fuels, we recommended using the LHV as dictated by the IMO in the 'Guidelines on the Method of Calculation of the Attained Energy Efficiency Design Index (EEDI) for New Ships.'¹⁹ For fuels not defined in this document, we recommend using the LHV determined by fuel sample analysis.

While using fuel consumption, fuel emission factors, and slip factors present a straightforward way to calculate emissions for Book & Claim, there might be a need to improve the accuracy of emission

measurements in the future. This could include using engine test bed measurement data for specific vessels (like NO_x Technical Files) or direct onboard emission measurements. These two alternatives must be studied further to understand their potential application for a Book & Claim system, as differences with existing frameworks may provide different values.

2.1.4 Emissions excluded from our Book & Claim system

Certain types of emissions are exempted from reporting to regulatory bodies. IMO's CII excludes the scenarios specified in Regulation 3.1 of Marpol Annex VI,²⁰ which may endanger the safe navigation of a ship. Similarly, the IMO's Energy Efficiency Operational Indicator (EEOI) excludes voyages for the purpose of securing the safety of a ship or saving life at sea.²¹ Meanwhile, EU MRV adopts a different approach by focusing solely on transport service rendered, which leads to more exclusions on non-cargo handling and non-passenger embarkation or disembarkation-related activities.²²

At this stage, our Book & Claim system will adopt a similar approach to IMO CII and EEOI, with exceptions for emissions resulting from activities that ensure the safe navigation of a ship or saving a life at sea. This includes:

¹⁶ If an inconsistency is found, the verifier shall request the records and documents to corroborate such inconsistency and report the non-conformity to registry administrator to define how the correction should be made.

¹⁷ The fuel consumption is a required additional data that should be reported along with the TTW emissions.

¹⁸ If a significant deviation is found, the registry administrator will make inquiries to the shipowner or operator to provide the appropriate documentation described in the methodology. If the inconsistency is corroborated, an appropriate adjustment will be made based on the official document provided.

¹⁹ [2018 Guidelines on the method of calculation of the attained energy efficiency design index \(EEDI\) for new ships](#), International Maritime Organization, 2018

²⁰ [Annex VI - Regulations for the Prevention of Air Pollution from Ships](#), MARPOL Training Institute

²¹ [Guidelines for voluntary use of the ship energy efficiency operational indicator](#), International Maritime Organization, 2009

²² [REGULATION \(EU\) 2015/757 OF THE EUROPEAN PARLIAMENT AND OF THE COUNCIL](#), European Union, 2015



- Stoppage for repair
- Aiding a ship that is in distress or in need of assistance
- Taking shelter from adverse weather for the safety of crew and ship cargo
- Taking an active part in search and rescue activities

In practice, our Book & Claim system will require all emissions to be uploaded within the voyage in consideration. Shipowners or operators must report if one or more legs in a voyage had an event falling within Regulation 3 of the MARPOL Annex VI. The increase in the emissions caused by such an event shall be excluded from the calculation of the WTW emissions. Therefore, the fuel consumption of those legs should be measured the same way that the entire voyage is measured. If the fuel consumption is unmeasurable (which must be justified), an estimation may be used. Estimations must use methods that can be corroborated and compared with benchmark values (e.g., modeled by routing software). This should be verified during the corresponding surveillance audit.

A voyage can also be flagged during a verification activity (i.e., initial audit, inter-audit verification, or surveillance audit) due to a disproportionate increase in fuel consumption or emissions, discrepancies in dates and port of calls, or any other data point or qualitative information that do not correspond to activities under normal operational and weather conditions. In such cases, the parties responsible for verification will make enquiries to the shipowner or operator regarding the occurrence of an event that could be categorized under Regulation 3 of the MARPOL Annex VI. If such an event has occurred, an appropriate adjustment will be made based on fuel consumption estimations using benchmark values (e.g., route modeling software).

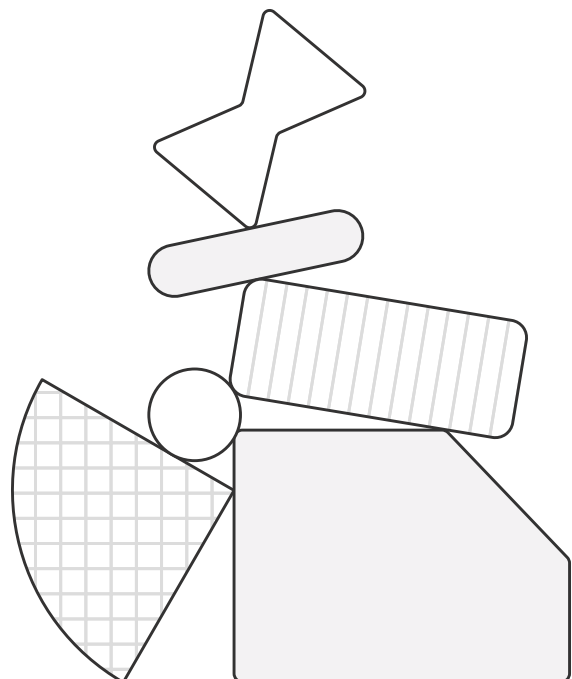





2.2 How participants collect transport activity data

2.2.1 Cargo data

The type of cargo carried varies from sector to sector, and so does the unit this cargo is measured in, as

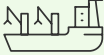
shown in Table 3. Our Book & Claim system will allow participants to disclose cargo quantity in several unit types. As the system matures, we may consider converting all cargo units to tonnes. However, there are currently no industry-accepted conversion factors for many cargo types, and we will not include conversion in our pilot.

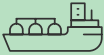
Table 3: Cargo unit by segment.

<p>Unit used to measure Cargo: Metrics tonnes</p>  <p>Segments using unit Bulk Carriers, Chemical Tankers, General Cargo, Oil Tankers, Refrigerated Bulk</p>	<p>Unit used to measure Cargo: Twenty-foot equivalent / forty-foot equivalent</p>  <p>Segments using unit Containers</p>	<p>Unit used to measure Cargo: Cubic meter</p>  <p>Segments using unit Liquefied Gas Tanker</p>
<p>Unit used to measure Cargo: Person / Vehicles</p>  <p>Segments using unit Ferry-pax, Ferry-RoPax, Cruise</p>	<p>Unit used to measure Cargo: RT (Unit of cars)</p>  <p>Segments using unit Ro-Ro, Vehicle Ship</p>	



There are three different options for determining how much cargo a ship carries, with increasing costs and complexity:

1. Self-disclosure: Shipowners/operators provide the data on how much cargo or how many passengers are carried with supporting documents.
2. Self-disclosure with verification: Shipowners/operators provide the data on how much cargo or how many passengers are carried with supporting documents. The system conducts surveys randomly to verify the integrity of the self-disclosed data.
3. Independent verification: Independent inspections on every voyage provide data for the Book & Claim system.

To reduce complexity while maintaining integrity, our Book & Claim system will require self-disclosure with verification. The supporting documents required vary by segment and are:

- **Bill of Lading (B/L):** Bulk Carriers, Tankers, Gas Carriers, Ro-Ro, and Chemical Tankers
- **Loading Plan:** Containers
- **Receipt of sale:** Ferries and Cruise Ships

A B/L is a legally binding contract measured and signed

off by a third party who provides the B/L. The captain's signature on this contract indicates that they agree with the quantity of cargo disclosed. The document declares the type and quantity of cargo to the vessel, which reports this information in their loading report, full away on passage (FAOP), or/and noon reports.

There are several possible methods for measuring the cargo disclosed in the B/L, including but not limited to the following:

- Mass/volume flow meters
- Calibrated loaders
- Tank soundings
- Draft surveys

While all cargo-related data in this system is measured in segment-specific units, a conversion to tonnes may be required in the future. If this is needed, cubic meter (CBM) units can be multiplied by the cargo density. A list of densities for cargo could be maintained in a centralized database. Ro-Ro vessels typically measure cargo in car equivalent units (RT or CEU). The quantity of vehicles is disclosed in the B/L, and this unit will be used for the pilot of our Book & Claim system. In the future, the number of vessels could be converted to tonnes if weight per vehicle is included in the B/L.

Loading plans indicate the number of containers loaded on a vessel by type and size and whether these containers are full or empty. Onboard a container ship, many types of containers can be present, as shown in Table 4.

Table 4: Container types and sizes.

Regular	High Cubed	Reefer*	Super reefer
20ft	20ft	20ft	20ft
40ft	40ft	40ft	40ft
	45ft		

*Reefer is a common industry abbreviation for refrigerated containers commonly used to transport perishables



In our Book & Claim system, the vessel will only disclose the number of each type and size of container for a given leg, hence simplifying the procedure for the user. The number of containers by type and size is also provided in the B/L, allowing for verification at a later stage. The shipping company's container management system can be audited to validate the number of containers disclosed for a given voyage.

The type, size, and full/empty levels of containers impact their relative share of fuel consumption. To cater for this, the Book & Claim system will convert all sizes to 20 ft equivalents of their given type. As reefer containers require additional electricity, a weighting factor could be used to allocate emissions to these specific containers. Discussions before a pilot will determine if this additional step for reefer containers is necessary.

The container segment also transports out-of-gauge cargo, defined as cargo that does not fit within a container. The pilot trial of the Book & Claim system will not capture the effects of out-of-gauge cargo. In the wider rollout of the Book & Claim system, out-of-gauge cargo may be included with discussion centered around weight and number of containers displaced due to its presence.

If conversion from container number to tonnes is required in the future, then verified gross mass (VGM) could be used. The VGM requires shippers to disclose the weight of the container before loading. This weight includes the tare weight of the container plus the weight of all its content. This can be measured by either weighing the container after being filled or by weighing its contents and adding this to its tare weight. However, a solution would be needed to allow for the additional fuel consumption of reefer containers.

A cruise ship's cargo is defined as the number of passengers carried. Cruise ships know the number of passengers onboard, either through digital cards that track passengers or via a manual counting system. The number of passengers onboard at the beginning of any given voyage is included in the embarkation list produced by the vessel. Embarkation lists can be validated by cruise sales receipts, which all companies must keep for tax-auditing purposes. As cruises are paid for before boarding, and voyages typically last days, gathering and reporting sales receipts to a Book & Claim system should not be overly difficult, especially if internal systems are implemented to automate this

process. If conversion from passengers to tonnes is required in the future, average weights for adults and children could be used.

A ferry's cargo is typically passengers and various types of vehicles. There is no standardization for how vehicles are defined, as companies will differentiate between vehicle sizes (both in dimensions and occasionally weight). Although there is no industry standardization, common pricing structures may typically include the following categories:

- Adult passenger
- Child passenger
- Car or 4x4
- Motorhome/minibus up to 6m long
- Motorhome/minibus up to 8m long
- Motorhome/minibus up to 10m long
- Commercial haulage
- Motorcycles
- Bicycle

To operate within our Book & Claim system, the ferry company would be asked to disclose the number of tickets sold for each category for a given voyage. For larger ferry lines, this information will be recorded at the point of purchase and, therefore, will be available for submission to the Book & Claim system before the voyage ends. The numbers provided by a ferry line to a Book & Claim system can be validated by sales receipts, again required for tax-auditing purposes.

If a conversion from passengers and vehicles to tonnes is required in the future, the Book & Claim system could use weighting factors for each of the above categories.

The focus of the cargo verification is to ensure, with reasonable assurance, that the cargo entered into the system matches the cargo listed on the B/L, loading plan, or sales receipts. According to the verification framework, the activities applicable are:

- **Initial audit:** The verifier shall validate the calculations of the first batch of voyages to be included in the Register and ensure no significant differences exist between the data the user intends to submit and the B/L, loading plan, or sales receipt.
- **Surveillance audit:** The verifier will use a randomized sample of voyages submitted since the last audit to determine if there is any inconsistency in the data reported. If so, the verifier shall request the records and



documents to corroborate such inconsistency and report the non-conformity to the registry administrator to define how the correction should be made.

- **Inter-audit verification:** A voyage can also be flagged during data submission (or uploading in the platform) if there is a significant deviation of the data registered from historical and benchmark values²³ for a specific shipping segment and vessel characteristics. If so, the parties responsible for verification will ask the shipowner or operator to provide the appropriate documentation (i.e., B/L, loading plan, or sales receipts). If an inconsistency is found, an appropriate adjustment will be made based on the official document provided.

2.2.2 Distance Data

Our Book & Claim system will define the distance traveled by a ship on a leg between two consecutive terminals/anchorage locations where cargo operations take place as the great-circle distance sailed overground by measurement of the ship's AIS systems along the leg, as recorded into the ECDIS (electronic chart display and information system). Distance recording starts when the ship leaves the terminal berth (or anchorage) of the most recent cargo operation for departure towards the next port. The sailing distance recording stops when the ship is alongside the terminal berth (or anchorage) in the subsequent port where cargo operations occur. Distance measurements for a voyage on this system will be self-reported based on AIS data.

Verification of the self-reported sailed distance on a specific leg is proposed to be done by a comparison with the leg distance derived from the ship's AIS position datasets with a small deviation allowance. If the AIS position datasets contain inconsistencies regarding time stamps or distance between two consecutive data points, then it is recommended to use the distance of the most direct route between the two ports. An adequate correction factor should be included when using the most direct route distance to avoid unrealistic underestimations of the sailed distance. The correction factor should be adaptive to geographical regions rather than a constant value and explicitly stated, along with the reported documentation.

2.3 Who submits data

The shipowner or operator will be the default party responsible for obtaining the above measurements and uploading them to the Book & Claim system. However, in the initial stages of this system, there will likely be cargo owners who want to participate but do not have shipowners/operators on this system. To accommodate for this, 'stranded' cargo owners will be allowed to upload data on their own behalf. However, they must obtain this data from their shipowner and operator. Estimates based on industry-average emission intensity data (i.e., using secondary data) will not be allowed, as primary data is a key feature of this system to maintain credibility.

There are two main challenges when verifying data from cargo owners whose shipowners/operators are not part of the system.

- **Unverified data:** The first challenge relates to applying the verification framework (as described in section 5.3) to any emission-related data. As a result, the emission-related data provided by stranded cargo owners cannot be verified or audited in the normal manner described by the verification framework. It will, instead, require the use of third-party systems or databases, along with default values, to flag potential discrepancies in the emission-related data reported by the cargo owners (similar to how 'risk-related verification' is done within the verification framework). It is important to note that the verification framework will still function as normal for all information related to stranded cargo owners' user and transaction data.
- **Completeness of data:** These cargo owners will likely be unable to access all the required information for token generation. While the tokens' face value can be calculated using primary fuel consumption data, additional information that is key for token exchange (e.g., fuel characteristics) and reporting purposes by scope 3 emission claimers might remain incomplete. There is not a clear and comprehensive final solution to address this challenge. Nevertheless, to facilitate the inclusion of users that do not have access to all the required data, one solution could be to develop categories of tokens labeled to reflect the varying levels of data completeness and assurance.

²³ Benchmark values might be generated by specialized analytical software such as AIS or weather-routing software.



It is important to highlight that if a classification solution is developed in future stages, it would also require the modification of the market rules to classify stranded cargo owners based on different levels of data. Also, since cargo owners may not provide all the additional information required (e.g., fuel type), the system will likely need to use the most conservative emission intensity estimations (e.g., a heavy fuel oil emission factor).

2.4 How often data is submitted

Our Book & Claim system will operate on a voyage basis and requires participants to upload data upon completion of each voyage. This system defines a voyage from the shipowner and ship operators' point of view, which requires understanding the following terms:

- **Leg:** Movement between two consecutive berths/terminals/anchorages for transporting passengers and cargo for a commercial purpose. For the purpose of this paper, movements between berths and anchorages within the same port are also referred to as a leg.
- **Cargo operation:** Activities of a vessel at berth or at anchorage in ports (e.g., handling cargo) that serve the purpose of transporting passengers and cargo for a commercial purpose:
 - **Port stay:** the period of time when a passenger ship stays in port where passengers embark and disembark.
- **Voyage:** A set of consecutive legs and cargo operations related to one or a set of aggregated transport services.

A voyage could be a trip, a route, a round, or a collection of activities during a period that follows the customary practices in each shipping sector. As a result, the exact definition of voyages can vary across segments. Typical voyages for each segment are described below.

For dry bulk carriers, chemical tankers, oil tankers, and liquefied gas carriers, a voyage is from discharge completion at the last discharging port of the previous voyage to discharge completion at the last discharging port of the voyage under consideration, including the

ballast leg(s), cargo operation, and laden leg(s). In some cases, a voyage could include a customary 'post ballast leg,' such as bringing a ship from a discharging port in a river port to the nearest river mouth pilot station where ships are in position to resume ocean-going sailing.

This customary 'post ballast leg' should be included in the voyage, and owners/operators need to prove there is no overlap between the 'post ballast leg' and the next ballast leg.

For container ships, a voyage is a route consisting of multiple legs and port calls for cargo operations, set as from the point of origin to the point of destination (the point of origin or destination could be the same point of origin if the route is a round route which starts and ends at the same place).

For ferries and cruise ships, a voyage is a route consisting of multiple legs and port stays from the point of origin to a destination (the point of origin or destination could be the same point if the route is a round route that starts and ends at the same place).

As no industry standard definition of voyage exists, our Book & Claim system will allow flexibility in defining voyages. The individual participant can decide what a voyage is if this definition adheres to the following rules:

1. No gaps are allowed between voyages (voyages are back to back).²⁴
2. Voyages should not overlap (voyages are mutually exclusive).
3. The shipowners/operators cannot selectively report or hide the ballasting voyage to artificially reduce emissions.
4. The definition of a voyage should be consistent with the allocation of emissions to cargo owners (see section 3.2.2).

2.5 System unit & tokens

When all data has been gathered for a voyage, this information is exchanged between participants. This section discusses the unit used in these exchanges (the system unit) and the properties of the information carrier for this data (token).

²⁴ It is a conceptual requirement that the methodology of defining voyage at the company level should be consistent. By requiring all voyages to be back-to-back, it does not mean the system requires all the voyages of a company to be uploaded to the system, especially at the early stage of the system. For governance purpose, the voyage before or after the voyage being uploaded may be needed by the registry administrator to methodology.



2.5.1 System units

Five potential system units were considered for recording emissions in our Book & Claim system. All are absolute measurements, not reductions:

1. Tonne CO₂eq (tCO₂eq): Total tonnes of CO₂eq emitted during transport activities.
2. Tonne maritime fuel: Tonnes of marine fuels used during transport activities.
3. Grams CO₂eq/Megajoule (gCO₂eq/MJ): Total grams of CO₂eq divided by the total energy consumed during transport service.

4. Grams CO₂eq/tonne-kilometer (gCO₂eq/tkm): Total grams of CO₂eq divided by the amount of transportation work.
5. Grams CO₂eq/segment-related volume or weight – kilometer: Total grams of CO₂eq divided by the amount of transportation work in the unit that transportation work is measured for a segment (e.g., tonne, TEU, CBM).

Four criteria consisting of 12 sub-criteria were used to evaluate the advantages and disadvantages of potential system units (see Table 5).

Potential system units were assessed against this criteria in Table 6.

Table 5: System unit evaluation criteria.

<p>Flexibility:</p> <p>Is the unit able to adapt to different segments and fuels?</p> <ol style="list-style-type: none"> 1. Segment: Can the unit be used across all vessel segments? 2. Vessel Size: Can the unit be used across all vessel sizes? 3. Fuel Type: Can the unit be used across all vessel sizes? 	<p>Tangibility:</p> <p>Is the unit easily measured and exchanged?</p> <ol style="list-style-type: none"> 4. Price Discovery: Is it easy it to relate the face value and number of tokens with the price of tokens? 5. Measurability: Is the unit easy to measure (e.g. requires measuring weight when volume is the standard) 6. Easiness to over-compensate/over-sell: does the unit enable players to cash in from selling or to compensate by buying unlimited number of tokens in case no restrictions imposed? 	<p>Value Adding:</p> <p>Does the unit add value to shipping industry?</p> <ol style="list-style-type: none"> 7. Rewarding efficient ships: Do more efficient ships generates more value with the set-up of the token? 8. Customer acceptance: Does the unit have intrinsic value to end customer? 	<p>Compatibility with Frameworks:</p> <p>Is the unit used in current frameworks?</p> <ol style="list-style-type: none"> 9. GHGP: in tonnes CO₂eq 10. Regional ETS: in tonnes CO₂eq 11. IMO CII/EEDI: in tonnes CO₂eq/tonnes-nautical miles 12. Potential IMO WTW index and FuelEU Maritime Proposal: in tonnes CO₂eq/MJ and tonnes CO₂eq/kwh
--	--	--	--



Table 6: Advantages and disadvantages of possible system units.

Unit	Advantages	Disadvantages
Tonne CO ₂ eq	<ul style="list-style-type: none"> - Flexible across vessel segments, sizes, and fuel types - Easy to benchmark price against carbon tax and ETS - Fewer measurements required (i.e., no cargo or distance measurements required) - Wide customer acceptance as this unit is normally used in reporting - Comptabile with GHG-P and various regional ETS 	<ul style="list-style-type: none"> - Easy to overcompensate and over-sell unless restrictions put in place. Participants with no reporting obligations can take more emissions and participants can over compensate their own emissions. - Transport service not measured, leading to misalignment with IMO CII and EEDI or future IMO WTW index and FuelEU Maritime Proposal - Transport activity is not reflected in the value Transport activity - Efficiency not rewarded by unit
Tonne maritime fuel	<ul style="list-style-type: none"> - Flexible across vessel segments, sizes, and fuel types - Price easily benchmarked against premium of alternative fuels compared to conventional fuels - Fewer measurements required (i.e., no cargo or distance measurements required) - Cannot over-sell as only the amount of alternative fuel consumed can be sold - Compatible with upstream fuel producers as the same as the unit of physical sustainable fuel traded 	<ul style="list-style-type: none"> - Conversion into CO₂eq must be done by end users/ cargo owners to be accepted internally and for external frameworks (difficult as different fuel types have different fuel emission factors) - Less efficient ships will generate more alternative fuel tokens compared to more efficient ships - Can over-buy as buyers could buy as many alternative fuel tokens as they want - Transport activity is not reflected in the value - A large variety of energy densities exist for maritime fuels. Tonnes do not reflect these different densities which can result in misleading comparisons.
Grams CO ₂ eq/ MJ	<ul style="list-style-type: none"> - Flexible across vessel segments, sizes, and fuel types - Less segmentation is needed as factors of the economy of scale and nature of trade (long or short haul) are removed - Only requires measuring emissions and fuel consumption - Compatible with future IMO WTW emission intensity index and FuelEU Maritime Proposal - Total CO₂eq can be calculated by summing up tokens - Conceptual alignment with upstream fuel-based Book & Claim systems - Cannot over-sell as only energy consumed can be sold 	<ul style="list-style-type: none"> - Less efficient ships will generate more tokens compared to more efficient ships, a potential issue for ships using alternative fuels - Transport activity is not reflected in the value - Can over-buy as buyers could buy as many low emission tokens as they want - Price cannot be directly benchmarked against carbon tax and ETS
Grams CO ₂ eq/ tonne-kilometer	<ul style="list-style-type: none"> - Flexible across vessel sizes and fuel types - Total CO₂eq can be calculated by summing up tokens - Efficient ships benefit from lower-intensity tokens - Compatible with IMO CII and EEDI - Similar to the distance-based method for emission calculation allowed by GHG accounting - Transport activity is reflected in value - Cannot over-sell as only transport service rendered can be sold 	<ul style="list-style-type: none"> - Requires measuring distance and cargo carried - Not all segments measure cargo based on tonnes-transport activity - Can over-buy as buyers could buy as many low emission tokens as they want - Price cannot be directly benchmarked against carbon tax and ETS
Grams CO ₂ eq/ segment related volume or weight – kilometer	<ul style="list-style-type: none"> - Same as using tonne-kilometer except also flexible across vessel segments 	<ul style="list-style-type: none"> - Challenges market liquidity as market segmented by denominators - Requires measuring distance and cargo carried - Can over-buy as buyers could buy as many low emission tokens as they want - Price cannot be directly benchmarked against carbon tax and ETS



The transport activity-based units (gCO₂eq/tkm and gCO₂eq/segment-related volume or weight-kilometer) have several advantages. They are compatible with regulations, similar to the unit of emission intensity factors used in GHG accounting frameworks, can be summed up to reflect the total CO₂eq, and reward more efficient ships.

However, using transport activity does not make sense for all segments. The business model for cruises and ferries is not centered around weight and distance. Cruises do not perceive distance the same way as cargo ships, as the routes of cruise ships are designed to provide experiences to the passengers, not to transport cargo efficiently. Secondly, not all segments measure cargo using tonnes as a unit. As discussed in section 2.2.1, no industry standard exists for converting these units to tonnes. Using a non-standard conversion factor may lead to a system unit that participants do not trust. Finally, using this system unit would create a large bandwidth of token values, with factors like ship size playing an increased role.

While the fuel energy content-based unit (gCO₂eq/MJ) is not without shortcomings, it also offers significant advantages. It is comparable across vessel segments, sizes, and fuel types as it is based on the energy consumed by the ship. It is the unit used by the proposed IMO lifecycle GHG/carbon intensity guidelines and it conceptually aligns with the other fuel-based Book & Claim systems. The total tonnes of GHG emissions from a voyage can be derived by users by simply summing up the tokens generated.

Based on this analysis, our Book & Claim system will use CO₂eq intensity per energy consumed (gCO₂eq/MJ) as its system unit. However, all transport activity information will still be measured to allow for the possibility of a transport activity-based system unit in the future.

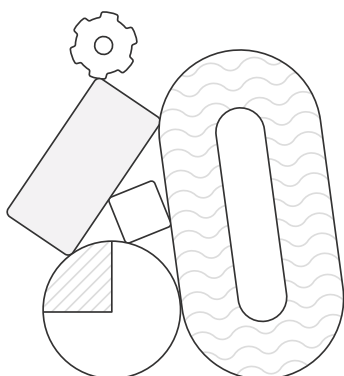

2.5.2 Token information

A token represents ownership and access rights to data that can be exchanged between Book & Claim platform participants. To facilitate trading, tokens carry a value in CO₂eq/MJ and a label stating the corresponding GHG emission category (scope 1 or scope 3). A more detailed definition and overview of tokens will be provided once the IT infrastructure is developed before the pilot.

Tokens represent four categories of data, as shown in Figure 2: essential data, additional data, optional data, and status records.

Essential data refers to all information describing the GHG emission intensity of the transport activity, which serves as the basis for issuing and allocating tokens. Essential data is the most important and must have the highest accuracy due to its direct impact on exchanges. Additional data is information needed to calculate and verify the essential data. All data included in these two categories must be disclosed to generate tokens. To safeguard data quality, this data must be measured and submitted in a validated process, and the system must verify the data inputs.

Optional data can be provided by participants on a completely voluntary basis. Participants are encouraged to provide additional data they believe could be value-adding to their token. Tokens can be generated without providing optional data.

The fourth data segment, status records, consists of information about the token itself. This data documents what actions have been taken on the token and is automatically created by the system. With each transaction, the token's status records will be updated. This ensures that a token's history will remain preserved. Status records prevent double claiming of both scope 1 and scope 3 emissions. (For a complete overview of the rules this Maritime Book & Claim system will impose to prevent erroneous double counting, see Box 2 - "Double counting"). As discussed in section 3.1, tokens need to carry marks showing the role of participants who have claimed them and what type of participant is still able to claim them. For the sake of simplicity, such status records will be referred to as tick marks.

Figure 2: Token data..

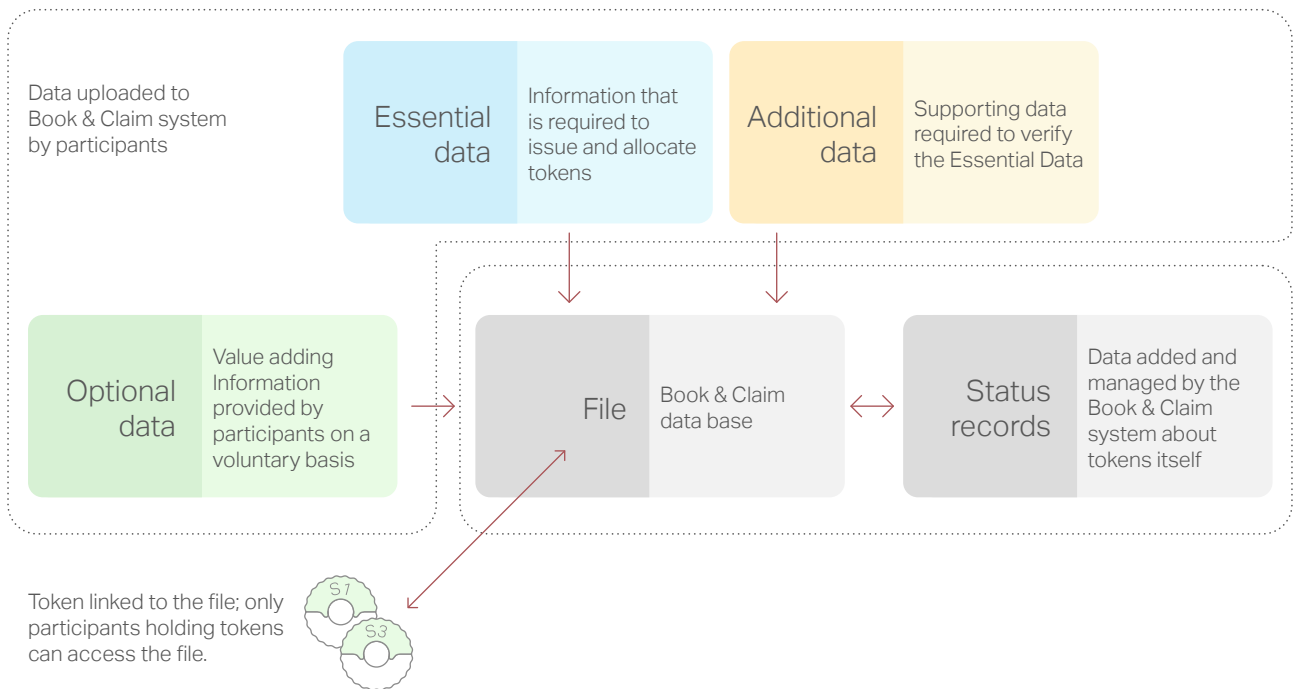

All participants will have access to essential and additional data for tokens they hold. Participants will have limited rights to access optional data. Participants will be given the option to choose and administer who can read optional data upon receiving a token by way of an access rights management tool to be developed. Certain information included in the status records will be visible to participants.

Within the system, tokens are categorized according to their emission scope label and can, therefore, be 'scope 1' or 'scope 3'. Tokens can also be categorized according to status records, for example their fungibility status. Fungible tokens grant their owners the right to exchange or pass them, while nonfungible tokens only entitle the owner to access related data.

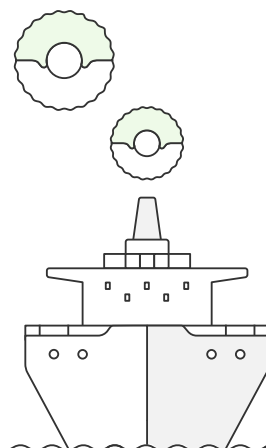

Box 1: Additionality

Additionality is a concept used to assess the causal relationship between an emission-reduction project and the decarbonization benefits. Decarbonization benefits are considered 'additional' if they would not have occurred in other scenarios without an emission-reduction project.²⁵ Testing additionality is critical for ensuring that the emission reductions in relationship to a determined baseline are real and appropriately quantified. For every 'additional' tonne of emission reduction, an extra tonne of emission is removed or avoided on top of the 'business-as-usual' scenario. In GHG accounting, GHG-P defines additionality as a term specifically associated with offsets.²⁶

However, the Maritime Book & Claim system is built on a different methodology than offsets. Emissions in this system are not derived from baselines, and emissions from both conventional and alternative fuels are included. This system creates a pool of emissions resulting from maritime transportation and allocates these emissions within the boundary of the pool. Rather than requiring every tonne of emissions to be additional, the Maritime Book & Claim system aims to reduce the size of the pool of emissions by replacing conventional fuel emissions with alternative fuel emissions over time. Therefore, additionality assessments used to qualify and quantify emission reductions against baselines are not applicable for emissions registered on the Maritime Book & Claim system.

However, organizations can also assess additionality through a different lens. They may prefer financing a new ('additional') supply of low-carbon maritime transport rather than merely sharing the cost of what would have 'happened anyway'. However, the complex and fast-changing regulatory, technological, economic, and legal landscape in the maritime industry makes defining what would have 'happened anyway' difficult.

The variety of maritime industry regulations can make it difficult to assess whether low-carbon maritime transport services are additional. There are blending mandates (e.g., FuelEU for Maritime), emission intensity regulations (e.g., IMO EEDI/EEXI, EEOI, and CII), emission caps (e.g., EU ETS), and reporting obligations. Furthermore, ships operate internationally but can be affected by a range of regional regulations. Although shipowners and operators are regulated under IMO and governed by international and regional laws, the cargo owners and end consumers are subject to other applicable rules and laws. This variety of interwoven regulations makes it difficult to assess whether emissions reductions are additional.

The technological, economic, and legal landscape of sustainability is fast developing. More technologies will become available in the coming years, and cost-effectiveness is constantly shifting. Furthermore, we expect more laws and regulations to be introduced and enforced in the coming years, further complicating determining whether emission reductions are additional.

As a result, our Book & Claim system will not assess whether emissions are additional. It will not compare emissions with a baseline, as is required to evaluate additionality for emission reductions (e.g., in offsets). However, it will provide all the necessary emission and transport activity information for participants to judge whether the low-carbon transport services are additional based on the participants' criteria. The criteria may differ between participants; hence, the Maritime Book & Claim system will not standardize the criteria before an industry consensus on the topic of additionality is achieved. There are currently several organizations attempting to set standards for how to apply additionality in Book & Claim frameworks. The Maritime Book & Claim system will continue to align with the latest insights and consensus on the topic of additionality and refine guidelines as necessary.

²⁵ [Carbon Credits and Additionality: Past, Present, and Future](#), World Bank, 2016

²⁶ [The Greenhouse Gas Protocol: A Corporate Accounting and Reporting Standard \(Revised Edition\)](#), Greenhouse Gas Protocol

Token data can serve as earmarks allowing participants to filter and select tokens according to their preferences and requirements. However, this function depends on the system's data protection policy and the participants' decisions.

Among all the preferences and requirements that each participant could have, one may be additionality (i.e., financing new supply low-carbon activities). Assessing additionality, a concept discussed in Box 1, requires clear and transparent information. This assessment will become more difficult with the increasingly complex and fast-changing regulatory landscape in the maritime industry.

Our Book & Claim system will be in a unique position to tackle such challenges. Earmarks will enable additionality tests, such as whether fuel is supplied and/or consumed in an area with blending mandates, whether the transport activity is rendered in a region where emission caps exist, whether the fuel is produced in a region with subsidies on sustainable fuel production, by the following three steps:

1. First, data such as where the fuel is supplied, where the fuel is produced, who the fuel supplier is, and what the ports of call of the voyage are, which are collected when voyages are registered, will be earmarked in tokens.
2. Next, the system will capture and map the up-to-date international and regional regulations including emission caps, fuel blending mandate, and fuel production subsidies in the database.
3. Finally, the system will generate earmarks if any regulations are applicable to every token and what the regulations are.

According to the participants' specific company policies and evaluations, they can use earmarks to:

1. Qualitatively check if tokens are subject to any regulations that have an impact on the additionality assessment.
2. Quantitatively obtain the details of each token to determine to what extent the token is additional.

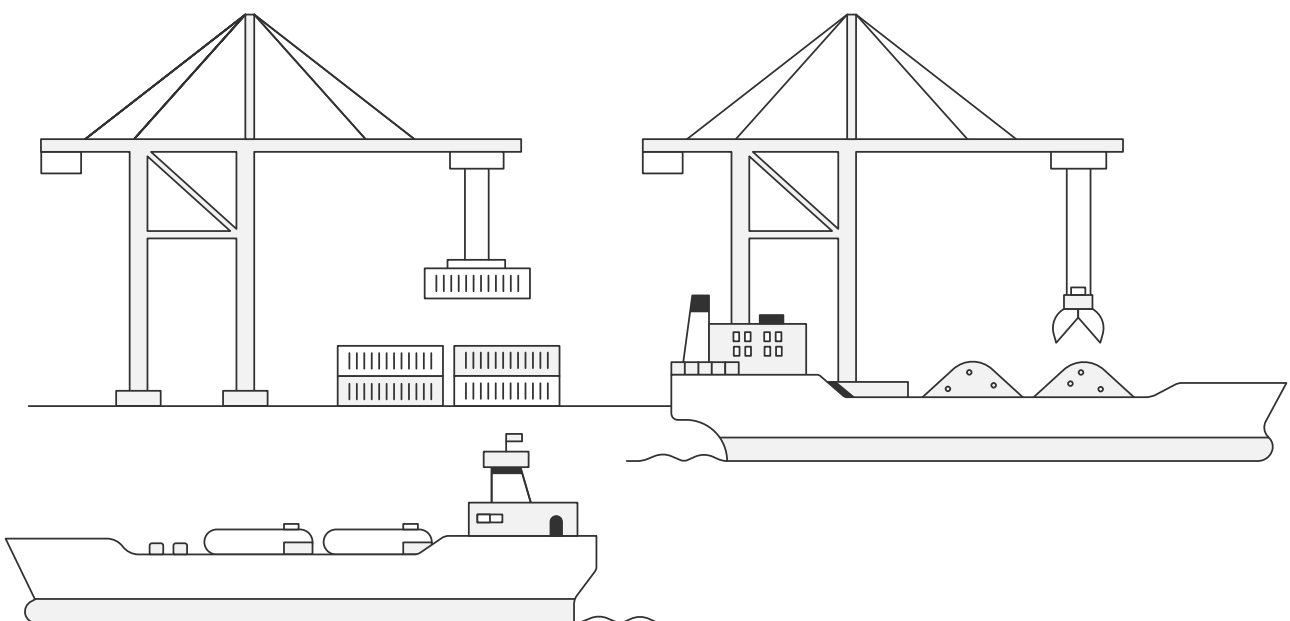

03

Market rules



3. Market rules

When all emission and transport service information has been collected for a voyage, participants will be able to generate tokens in the Book & Claim system. The tokens can then be used for processes including booking, allocating, claiming, and passing. This section outlines who the system participants will be and describes token processes. The allowed time period for transactions and the segmentation rules for our system are also described.

3.1 Participants

As our Book & Claim system design is focused on the maritime industry, participants must be companies directly related to transporting goods via ships or companies purchasing this transport. Any company that fits into one of the four roles described below will be allowed to participate in the Book & Claim system.

1. Shipowners: Companies that own ships as assets and manage them in-house or by outsourcing to technical management companies.
2. Ship operators: Companies that make commercial decisions about voyages and render transport services.
3. Freight forwarder: Companies that do not own cargo, but render transport services (often intermodal transport services) to cargo owners and procure the transport services from the ship operators on behalf of cargo owners. Freight forwarders could appear as the carriers in freight contracts with the ship operators.
4. Cargo owners: Companies that own cargo (could be either the seller/shipper or the buyer/receiver, and the ownership could change before, during, or after the voyage) and pay for transportation.

While any organization fitting the above roles can participate in this system, only vessels exceeding a size of 5,000 gross tonnage can participate in this system, in line with IMO's CII size requirement.

Preventing incorrect double counting is a critical principle safeguarding the integrity of the Book & Claim system.²⁷ The system categorizes the participants into four distinctive roles (shipowners, ship operators, freight forwarders, and cargo owners), representing different levels of the supply chain. The sequence of these four roles is illustrated in Figure 3.

Figure 3: Sequence of Supply Chain.

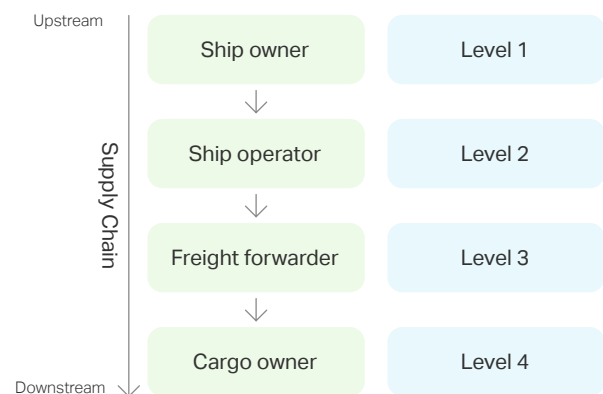

When a transport service is rendered, these four roles often exist simultaneously along the same supply chain as different entities reporting their own GHG emissions. Our Book & Claim system design considers double counting between the four roles to be correct (e.g., a ship operator and a cargo owner could claim the same emission profile/the same token). In contrast, double counting within the same roles is incorrect (e.g., two ship operators should not claim the same emission profile/the same token). The system only allows a token to be claimed by one shipowner, one ship operator, one freight forwarder, and one cargo owner. For each voyage registered, participants must identify the role they play in that voyage. The system will then label them with that role for the voyage. Tokens are not allowed to be claimed twice by participants with the same role.

Assigning concrete roles for maritime transport can be difficult, as organizations can have multiple roles in a voyage, for example if shipowners operate their own ships. Furthermore, more than one organization can have the same role, for instance if vessels carry cargo from multiple owners.

²⁷ For a complete overview of the rules this Maritime Book & Claim system will impose to prevent erroneous double counting, see Box 2.



Organizations can also have the same role and be responsible for the same emissions from an activity. For example, a ship operator could sub-lease ships to another operator for profit. Theoretically, there could be unlimited numbers of ship operators behind one piece of transport service rendered.

Nevertheless, regardless of how many ship operators are involved in the transport service, one operator ultimately makes the decisions on voyages (who actually operates the ship), while the rest are chartered in and out. This ship operator is usually the last chain and enters the charter party (often the voyage charter party) directly with the freight forwarders or cargo owners. Similarly, for freight forwarders, one company purchases services from ship operators, while the others sub-lease cargo transport contracts.

Our Book & Claim system provides the following guidance for defining roles. For each voyage:

- One participant is allowed to identify themselves as one or more roles.
- Two or more participants cannot declare the same role if they are accountable for the same emissions resulting from the same activity (transportation of the same cargo).
- Two or more participants can declare the same role if they are not accountable for the same emissions resulting from the same activity (transportation of the same cargo).

The registry administrator grants access to the system following the rules of the 'know-your-customer' policy²⁸ and the system's requirements based on the type of user. Some of the requirements may include financial information and collateral to support the transactions on the exchange platform. The registry administrator can refuse to grant access for any of the following reasons:

- If the information the user provides is incomplete, inaccurate, unreadable, or outdated, or if the user does not give the complementary information in the terms established by the registry administrator.

- If the registry administrator, by any means, identifies that the user is under investigation or has been convicted of fraud, money laundering, terrorist financing, or other serious crimes.

In the future, other participants may be granted access to this system to help certify and audit data, facilitate trades, or provide other value-adding services.

3.2 Processes

This section describes the actions or processes participants can take with tokens within the Book & Claim system, including booking, allocating, claiming, passing, and swapping. These processes allow participants to use tokens to fulfill their obligations regarding GHG reporting. These responsibilities include:

1. Reporting their emissions: Companies will report GHG emissions from their transport service.
2. Facilitating emissions reporting for the upstream and downstream portions of its supply chain: A company's suppliers and customers must report scope 3 emissions based on transport services.

Our Book & Claim system will allow participants to make two decisions reflecting their GHG emission reporting responsibilities.

1. **What GHG emissions will they claim for GHG reporting?** Upon receiving tokens, if participants are satisfied with the GHG emission intensity levels represented by the tokens, they can claim them for GHG reporting purposes. If they are unsatisfied, they can swap them on the Book & Claim platform and claim the tokens they receive in the swap instead. This process is illustrated in steps 1-3 in Figure 4.
2. **What GHG emissions will they pass downstream?** Upon claiming tokens, the participant must transfer the same number of tokens down the value chain. If they would like to transfer tokens representing different GHG emission intensity levels than they claimed, they can swap them on the Book & Claim platform and transfer the tokens received in the swap. This process is illustrated in steps 4-6 in the below diagram.

28 This policy will define the guidelines for verifying the identity of users and assessing their risks of involvement in practices within the scope of anti-money laundering and counter-terrorism financing regulations.



Figure 4: Overview of 2-step decision process.

The Book & Claim system begins when transport work is measured and registered in the system, creating tokens. Once tokens are generated, they follow the flow described below.

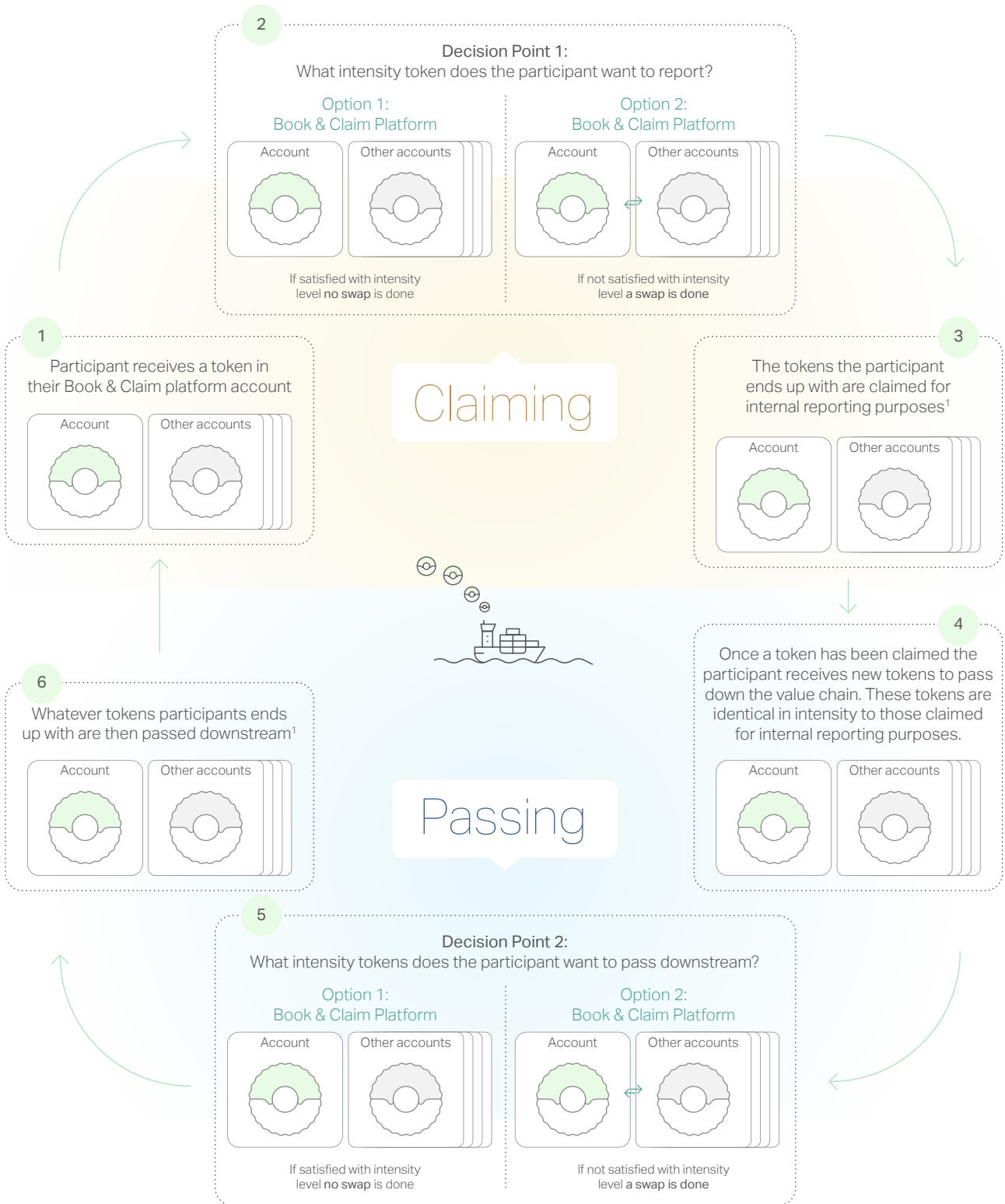

NB! For illustration purposes tokens are not assigned a Scope, but both Scope 1 and 3 tokens will be on platform.



3.2.1 Booking

Booking voyages is the first step taken for participants to begin using tokens. Upon completion of a voyage, participants upload the information for the voyage, and once this data is verified tokens are issued. These tokens are automatically uploaded to the registry.

The three basic steps of the booking process are uploading, verifying, and booking. Once a participant has completed a voyage, they have a maximum of three months to upload this voyage to the Book & Claim system (see section 3.3). As discussed in section 2.3, a shipowner, ship operator, or 'stranded' cargo owner can upload data. Participants must upload all required essential and additional data and potentially optional data in line with the system's requirements (outlined in Chapter 2). The mechanism of this exchange will be detailed during the development of the IT system to be used for this system. The voyage participants must then agree on who uploads this data, as only one set of tokens will be allowed per voyage.

Once information is uploaded, it needs to be verified to maintain the credibility of this system. This verification ensures that the data properly reflects the voyage characteristics (e.g., vessel and the fuel used, distance, cargo) and emission ownership. The methodology to verify data will be further described in the Book & Claim manual, but considerations will include the following:

- Ensuring all required data is included and measured according to system requirements.
- Benchmarking information with historical or default data that considers the type and size of vessel, fuel, distance, and cargo transported.
- Ensuring that a voyage has not already been booked in the registry to avoid double booking.

If any issues are raised during this verification process, additional information will be required from the user to clarify any issues. Benchmarking information and databases used to verify this information will be confirmed in the pilot preparations.

Once the uploaded data has been verified, tokens will be issued to the participant. One token will be issued per MJ of fuel consumed. These tokens contain all essential, additional, and optional data as well as initial status records.

Scope 1²⁹ and 3 tokens are generated simultaneously and will be identical in every way except for their scope markings. Shipowners and operators must negotiate and agree to the initial allocation of tokens before uploading data and requesting issuance. Theoretically, there are four ways to distribute scope 1 and 3 emissions, as illustrated in Figure 5.

Figure 5: Scope 1 and 3 allocation.

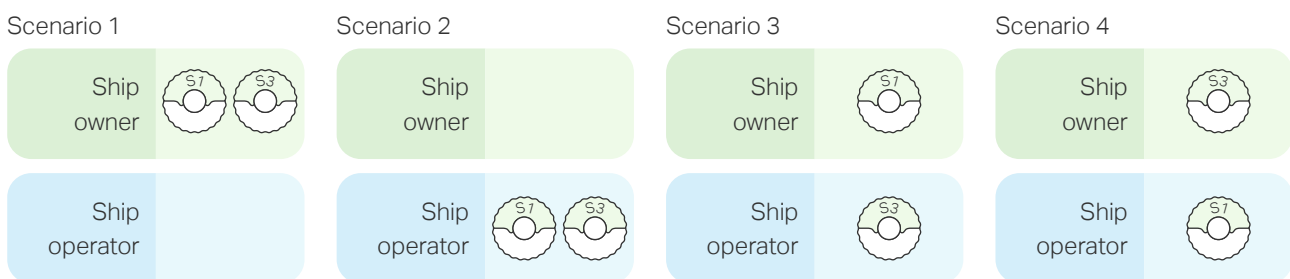

29 Scope 1 tokens will be booked and swapped in the pilot of this system, but their continued use will be evaluated after the pilot.



In scenario 1, the shipowner receives both scope 1 and 3 tokens. The shipowner can only claim scope 1 tokens, but has the right to monetize by swapping or passing their scope 1 and 3 tokens. From the shipowner's perspective, these scope 3 tokens are simply trading assets. In scenario 2, the ship operator receives both scope 1 and 3 tokens. The ship operator can only claim scope 1 tokens, but has the right to monetize by swapping or passing their scope 1 and 3 tokens. From the ship operator's perspective, these scope 3 tokens are simply trading assets. In scenario 3, the shipowner receives scope 1, and the ship operator receives the scope 3 tokens. The shipowner can claim, or swap and then claim the scope 1 tokens. The ship operator can claim, or swap and then claim scope 3 tokens. In scenario 4, the operator receives the scope 1 tokens, and the vessel owner receives the scope 3 tokens. The shipowner can claim, or swap and then claim the scope 3 tokens. The ship operator can claim, or swap and then claim the scope 1 tokens.

If blended fuels are consumed, and each component of fuel that goes into the blend carries a valid certificate that meets the system's requirements, participants have two options for generating tokens. The first option is to book tokens reflecting the GHG emission intensity of the blend. In this option, only one type of token is generated with a value reflecting the average GHG emission intensity of the blend. The second option is for participants to book tokens as if the blend's components were consumed separately. This will generate tokens with different values reflecting each fuel component.

To facilitate participants who would like to drive additional low-carbon transport services (see 2.5.2 Token information and Box 1 Additionality), the Book & Claim system will record specific data related to all fuels, including blended fuels. This Book & Claim system will record what has physically been bunkered, i.e., it will be documented that a specific mix of fuels was delivered as opposed to the delivery of separate fuels. Furthermore, all tokens derived from blended fuels will carry information about potential blending mandates in place. For example, a token could include information stating it was generated with a blend subject to a 2% e-fuel blending mandate. The details of this approach will be tested and further refined before and during the pilot.

3.2.2 Allocating

When a shipowner or operator uploads a voyage to the Book & Claim system, multiple freight forwarders and/or cargo owners will most likely be waiting to be allocated tokens. The shipowner or operator must decide how to allocate these tokens between downstream participants, and the system will provide guidance on how this should be done. Before allocating, participants must disclose to the system which organizations are downstream participants in their supply chain and will have emissions allocated to them.

As these tokens represent scope 3 emissions, the system could replicate existing guidance for allocating scope 3 emissions. Today, allocating scope 3 emissions to supply chain partners is largely left as an individual decision for each company. However, GHG-P does offer some guidance, suggesting that companies should select an approach for allocating emissions that:³⁰

- Best reflects the causal relationship between the production of the outputs and the resulting emissions
- Results in the most accurate and credible emissions estimates
- Best supports effective decision-making and GHG reduction activities; and
- Otherwise adheres to the principles of relevance, accuracy, completeness, consistency, and transparency.

The default method for allocation in our Book & Claim system will be assigning the emissions generated during each voyage to the cargo or passengers onboard during the voyage, and allocate the emission associated with each piece of cargo or each passenger to the owner of the cargo or the passenger/passenger organization.³¹ For example:

1. When there is only one piece of cargo owned by one cargo owner, or only one passenger/passenger organization, onboard the vessel during the voyage, all the scope 3 emissions of the voyage will be allocated to the sole cargo owner or passenger/passenger organization.

³⁰ [Corporate Value Chain \(Scope 3\) Accounting and Reporting Standard](#), Greenhouse Gas Protocol

³¹ Passenger organization refers to the organizations who act on behalf of the individual passengers on the Book & Claim system. Passenger organization could be companies that account for the emissions resulting from the travel of their employees, or travel agencies who account for the emissions resulting from the travel of their customers.



- When there are multiple pieces of cargo owned by multiple cargo owners or passengers/passenger organizations onboard the vessel during the voyage, the scope 3 emissions of the voyage will be assigned to the cargo or the passengers according to their respective weight (or sector-specific units), or the number of passengers multiplied by the distance traveled. Each cargo owner or passenger/passenger organization will then be allocated with scope 3 emissions according to the cargoes they own or the number of passengers they represent.

In reality, how transport services are rendered can make allocation difficult due to ballast leg emissions, transport activity occurring over multiple voyages, and emissions rendered by non-transport work. These challenges are described in more detail in the following paragraphs.

Many ships sail without any cargo or passengers to get to a loading port or port of embarkation. For example, in dry and wet bulk shipping, the loading ports are often not the discharging ports. This results in ships sailing in ballast between the laden legs. An example of this can be found with a dry bulk carrier that specializes in shipping iron ore. Such a ship could load iron ore from Brazil and discharge this cargo in Asia, but is unlikely to find cargo in Asia to transport back to Brazil. As a result, the ship must sail to another area to find cargo to transport. Emissions from ballast legs are often

unavoidable due to trade patterns. As laden legs cause ballast legs, when pricing freight, the cost of ballast legs is often allocated to the next laden leg, as the ship is brought to the loading ports by request of the cargo owner/shippers. The same logic could also be applied to emissions, making cargo owners responsible for the ballast emissions caused by the transport services they require. The Sea Cargo Charter follows this principle and provides guidance on which emissions a cargo owner (charterer) is responsible for in dry bulk and tanker shipping.³²

Our Book & Claim system will assume that when there is only one cargo owner or passenger/passenger organization, they are responsible for emissions from the ballast leg. When multiple cargo owners or passenger/passenger organizations are on a voyage, emissions from the ballast leg will be allocated based on the transport services rendered to the respective cargo owners. The total emissions of the ballast leg will be allocated between cargo owners proportional to their share of the transport service (cargo carried and distance traveled).

Transport activity spread over multiple voyages could present challenges for allocating emissions. However, our Book & Claim system will define voyages from a shipowner or operator’s point of view. This means that transport work for a cargo owner can occur over several voyages. In this instance, the cargo owner gets allocations from two voyages.

Figure 6: Example of transport occurring over two voyages.

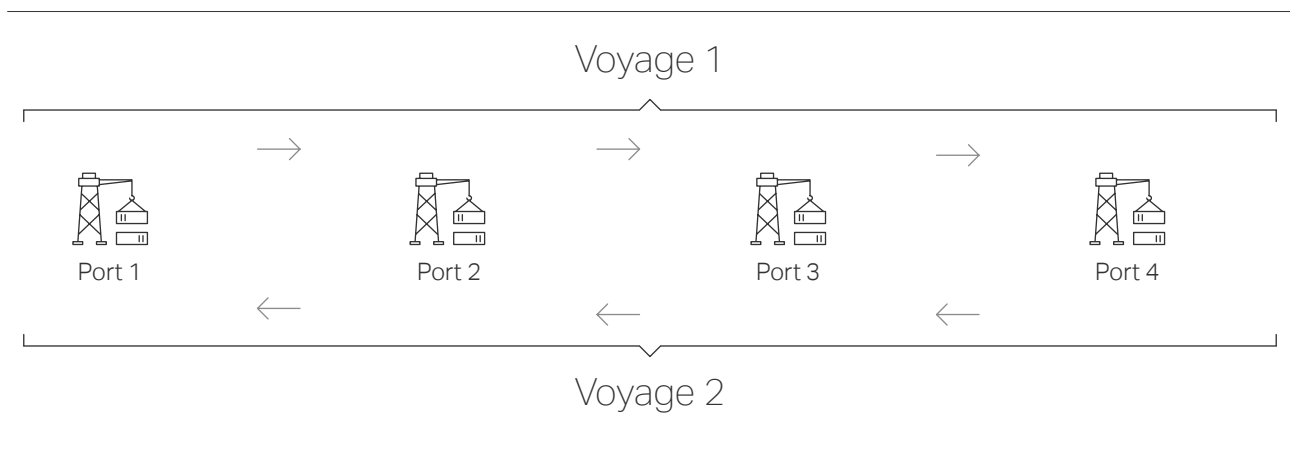

32 [Sea Cargo Charter](#), Sea Cargo Charter



Figure 6 shows a container vessel operating a round route between ports 1 and 4. They define sailing from port 1 to 4 as one voyage and from port 4 to 1 as a different voyage. If a cargo owner ships cargo from port 3 to 2, they will be responsible for the emissions from port 3 to 4 to 3 to 2. These emissions occur across two voyages.

Emissions from non-transport activity also present a challenge for Book & Claim. Not all activities of a ship are related to providing transport services. For example, ships must be serviced, maintained, repaired, manned, and inspected. Only shipowners are responsible for the GHG emissions during these processes. In principle, the emissions from non-transport activity should be counted as the scope 1 emissions for shipowners, not scope 3 emissions for cargo owners and the parties down the supply chain. To date, there is no widely accepted list of activities to be counted as scope 1 but not scope 3. The general principles for allocating scope 3 emissions are similar to allocating the cost. If the operator or cargo owner is not responsible for the cost of an activity, they are unlikely to count the emissions towards their scope 3.

Commercially, the activities not related to transport services are defined as 'off-hire' under the time charter party (usually between the shipowner and the operator). The details of 'off-hire' activities can vary from voyage to voyage and contract to contract. Our Book & Claim system will not allocate emissions from 'off-hire' periods to any cargo owner, and these emissions can only be counted as scope 1 emissions by shipowners or operators. The Book & Claim system will request the shipowner or operator who tokenizes emissions to provide the exceptions for scope 1 and 3 emissions and the charter party governing the voyage with mutually agreed off-hire period definitions.

The above issues may mean that the system's default guidance for allocation may not always be appropriate. Therefore, as long as the below rules are followed, this system accepts flexibility in allocating scope 3 emissions:

1. Transport service-related emissions are counted as scope 1 and 3, but non-transport service-related emissions can only be counted as scope 1 emissions.

2. All scope 3 emissions must be allocated downstream.
3. No overlap is allowed between the amount of scope 3 emissions generated and those allocated to customers.

Once this allocation has been decided upon, all affected parties should be informed about the allocation. Once informed, these parties should ensure that their reported scope 3 emissions align with their allocation. The shipowner/operator is responsible for notifying the responsible parties of their scope 3 emissions before tokenizing the voyage to prevent erroneous double counting.³³

To verify the allocation, the Book & Claim system will:

- Verify the business relationship between the allocating and allocated parties through supporting documents such as the B/L.
- Verify if the transaction is being made within the acceptable period according to the token's timestamp and fungibility rules.
- Verify if there is any 'alert' about this token highlighted either during the audit cycle or by complaint (or any other additional alert that might be included in the system).
- Compare the scope 3 allocated to a specific user with the total amount generated and amounts allocated for related voyages.
- Verify that the deductions of non-transport activity are supported by documents such as the 'off-hire' related clauses in the charter parties. Over time, the system will build a database of off-hire emission deductions, which can be used to flag abnormal deductions submitted by the users.

In case of discrepancies, the registry administrator will ask users to provide the criteria to determine the allocation and the documentation supporting it. Over time, the system might be able to capture the rules that are specific to certain shipping segments and voyages and flag possible abnormal allocations.

³³ For example, a cargo owner sailing on a vessel burning alternative fuel may receive fossil fuel scope 3 tokens. This would happen in instances when a shipowner swaps alternative fuel tokens prior to passing to the cargo owner. If this cargo owner still reports alternative fuel emission levels due to their knowledge of the fuel used on the ship, this would be double counting. For a complete overview of the rules this Maritime Book & Claim System will impose to prevent erroneous double counting, see Box 2.



3.2.3 Claiming

Once a participant is satisfied with the emission intensity of their tokens, they need to report their emissions GHG emissions based on these tokens. The result of this claiming should be reflected in the participant's emissions reporting. Before reporting on a token, participants need to 'claim' these tokens, which will render these tokens nonfungible. A token is only allowed to be claimed once per role. Thus, upon being claimed, a token records the role of the participant who has claimed it via a 'tick mark' (the status record representing the claim status of each token). Participants have three months to claim a token they have received (see section 3.3).

Claiming will end the Book & Claim process for scope 1 tokens, which can only be claimed once. It will also end the process for tokens claimed by participants at the end of the identified supply chain, as there are no further downstream participants. However, if claiming involves a scope 3 token that is not the end of a transport chain, tokens will still need to be passed down. To facilitate this, the system will replicate the claimed scope tokens.³⁴ The participant who has claimed the tokens can either pass these replicated tokens down the transport chain, or swap them and then pass them down the transport chain.

There are two situations where a token is automatically claimed and passed by the system: if a participant fails to claim a token within the 3-month time limit, or if a participant is skipped, as described in section 3.2.6.

The verification/validation of the claiming transaction aims to mitigate double accounting and ensure the proper retirement of the tokens. To verify claims, the system will.

1. Verify if the transaction is being made within the acceptable period according to the token's timestamp and fungibility rule.
2. Verify if there is any 'alert' about this token highlighted, either during the audit cycle or by complaint (or any other additional alert that might be included in the system).

If any verification fails, the transaction is aborted. If not, the administrator retires the token from the registry.

3.2.4 Passing

Participants in this Book & Claim system are part of a supply chain. As a result, upon completing their services related to transport, participants are responsible for transferring information about emissions down their supply chain. Passing tokens is an important feature of our Book & Claim system that will incentivize all transport chain participants to collaborate to reduce emissions.

Upon claiming a token, identical tokens are replicated to allow passing, except in cases described in the previous section on claiming. At this point, the participant must decide the GHG emission intensity of the tokens they intend to pass on. Once this decision is made, participants can request to pass the tokens to the next participant in the supply chain. Participants have three months to pass tokens (see section 3.3).

To verify passing, the system will:

- Verify that the token sender has authorized the token receiver to receive tokens. For example, verifying that a cargo owner has received tokens from upstream (shipowners, operators, forwarders) under a contract or agreement based on the rendered services.
- Verify if the transaction is being made within the acceptable period according to the token's timestamp and fungibility rules.
- Verify the status of the audit cycle (e.g., timely completion of initial and surveillance audits).

If any verification fails, the transaction is aborted. If not, the administrator updates the change in ownership in the registry.

3.2.5 Swapping

Swapping emissions will allow our Book & Claim system to link supply and demand for low-emission shipping. Participants using low-emission alternative fuel receive

³⁴ Tokens are replicated only figuratively as the total number of tokens does not change. In practice, tokens are marked as 'claimed' by a specific role and are able to be passed further downstream.



low-emission intensity tokens that they can swap with other participants who want to lower their emissions. Likewise, participants without access to low-emission

fuels can find low-emission fuel tokens on this system and swap their emissions for them, as shown in Figure 7.

Figure 7: Illustrative example of swapping.

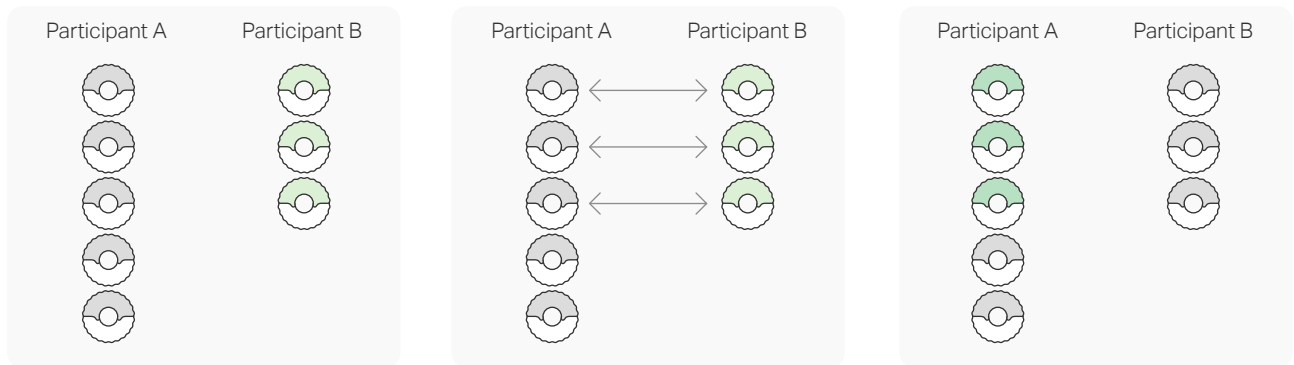

Step 1:

Participant A has high emission intensity tokens and wants to reduce their emissions.

Participant B has low intensity tokens but no one in their supply chain is willing to pay a premium for low emissions.

Step 2:

These participants agree to swap emissions

The financial component of this transaction is outside the system

Step 3:

The swap is completed

While Participant A cannot completely replace its high emission intensity tokens, they can find a different participant with low emission tokens to swap the remaining two tokens with if they would like.

Tokens can be swapped between participants as long as they hold fungible tokens. Swapping entitles participants to agree to exchange any number of fungible tokens, as long as each participant maintains the same number of tokens. Participants can swap tokens multiple times within the token holding period of three months, after which time tokens are automatically claimed or passed on. This system will impose certain restrictions regarding who can swap with who. This is further discussed in section 3.4.

Upon completion of a swap, the system will compare the 'tick marks' of all the tokens involved in the swap and mark all the tokens down to the lowest level of the participants who have made claims on any of the tokens. For example, if a set of tokens marked to freight forwarders swaps with a set of tokens marked to ship operators, the system will add tick marks of freight forwarders in the tokens marked to ship operators only. But, if all the tokens involved in the swap are marked for ship operators only in the tick marks, the system will not add additional tick marks.

To verify swaps, the system will:

- Verify that tokens follow the segmentation rules.
- Verify that users swap the same quantities of tokens to avoid leakage.
- Verify if the transaction is being made within the acceptable period according to the token's timestamp and fungibility rules.
- Verify the status of the audit cycle (e.g., timely completion of initial and surveillance audits).

If any verification fails, the transaction is aborted. If not, the administrator updates the change in ownership in the registry.

3.2.6 Skipping

Theoretically, scope 3 tokens can be exchanged across transport chains between any type of participant



holding fungible tokens, independent of the sequence of participants defining the respective chains. Since tokens could have different claim statuses on each transport chain, depending on how many participants they have been claimed by before being swapped, there might be situations where one participant receives tokens he is not entitled to claim anymore, while the other gets tokens that some or all preceding participants have not claimed.

Figure 8 depicts a simplified example of such a process, comprising two transport chains with the same number

of participants. In both cases, scope 1 tokens had been allocated to the vessel owners (excluded for simplicity), and scope 3 tokens had been allocated to the shipping operators. While the shipping operator of chain A is running its vessels on conventional fuels, his counterpart on the second chain B has chosen to operate the ships on an alternative fuel. The shipping operators have claimed their scope 3 tokens without any swapping (first part of the 2-step decision taken). Then, the flow of scope 3 tokens comes into play, as shown in Figure 8.

Figure 8: Skipping illustrated.

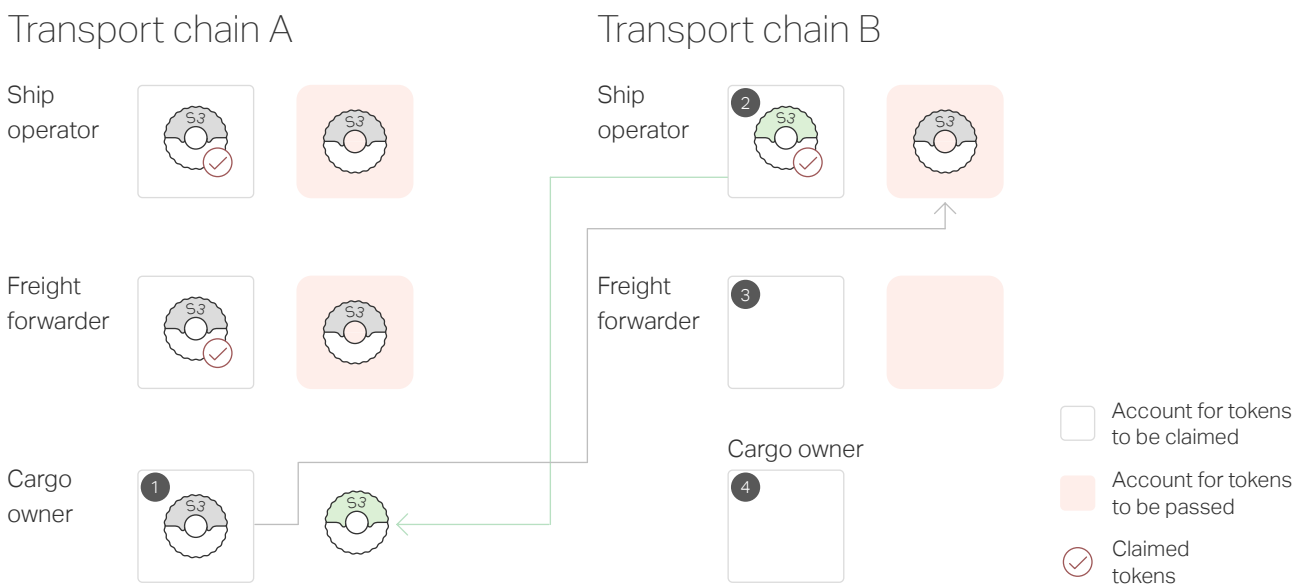

In step 1, the tokens in transport chain A are claimed and passed on from the shipping operator to the freight forwarder until they reach the cargo owner A. Cargo owner A decides to swap their tokens, as they are unsatisfied with the emission intensity profile represented by the tokens they received. In step 2, cargo owner A finds shipping operator B, who has low-emission intensity tokens they would like to monetize. Both participants agree on swapping. Shipping operator B receives tokens that have already been claimed by

a shipping operator and freight forwarder, while cargo owner A receives tokens that have only been claimed by a shipping operator. Upon completion of this swap, the tokens received by cargo owner A are automatically ticked to a cargo owner level. As a result, in step 3, the shipping operator from transport chain B does not have tokens its freight forwarder can claim, causing an interruption of the token flow. The system automatically executes the processes shown in Figure 9 to resolve this situation.



Figure 9: Resolving skipping.

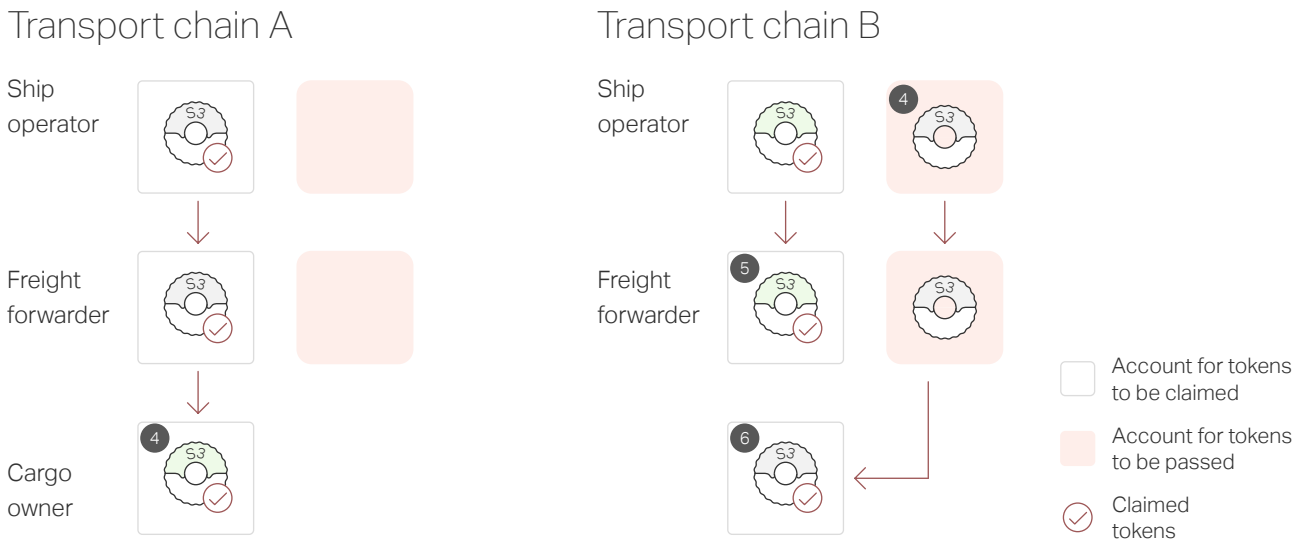

In step 4, cargo owner A claims the tokens received through the swap. Shipping operator B passes the received tokens to the freight forwarder, who is left with tokens they can't claim. In step 5, the system steps in and forces freight forwarder B to claim the tokens that shipping operator B owned before the swap. During that process, freight forwarder B is skipped, as the system automatically acts on their behalf. Finally, in step 6, the system automatically passes the token the shipping operator received in the swap to cargo owner B. Effectively, this skipping has the same outcome as if cargo that owners A and B swapped.

The fundamental principle behind this process is to enforce outcomes as if the initial swapping had taken place between participants with the same roles. One disadvantage of this mechanism is that all the participants affected by the enforced claiming and passing, except for the last one, will be deprived of the right to exchange tokens and the ability to decide what they want to pass on. We assume that such situations will trigger direct discussions between participants, effectively reducing the occurrences of skipping. The system will closely monitor situations resulting in skipping, and corrective measures might be implemented if needed.

3.3 Time allowed for processes

Participants need to make many decisions during the Book & Claim processes. Allowing sufficient decision-making time must be balanced with the desire for downstream participants to receive tokens. Furthermore, time restrictions must consider alignment with reporting compliance frames, market liquidity issues and volatility, and participant market engagement. Generally, longer fungibility periods may favor individual participants who benefit from a longer trading window to find the best counterparty for a swap. However, allowing longer fungible periods creates more supply at any given time, as the fungible periods of more tokens will overlap. If there is an oversupply of tokens, more time may be required to rebalance supplies.

There are three options for token fungibility within a Book & Claim system: the system can set a fixed time period, for example three months, in which tokens must be transferred; participants could negotiate fungibility periods; or there could be no time limit on fungibility, with pressure from down the supply chain driving fungibility periods.

Our Book & Claim system will initially use a fixed fungibility period of three months, as shown in Figure 10. The fungibility period will be adjusted once more data is gathered up to and during the pilot and will be continuously modified by the system to drive the desired liquidity and robustness of the marketplace.



Figure 10: Time limit for processes.

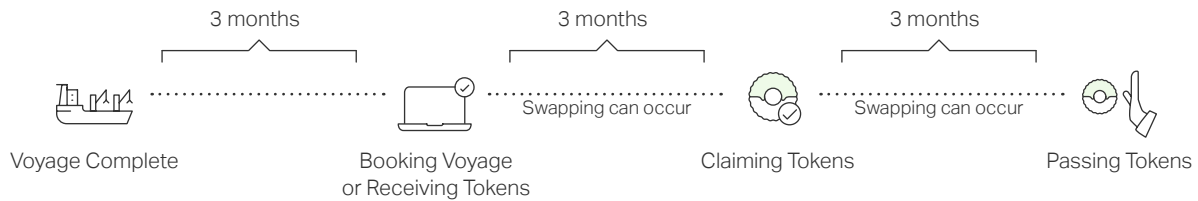

3.4 Segmentation

Our Book & Claim system design is fuel agnostic. As a result, we expect there will be a wide range of tokens with different emission intensity profiles across and within different segments. Any decision to limit trading by segments or token type will impact the system. Too much segmentation could lead to a system that doesn't link supply and demand, but too little segmentation could drive the wrong behavior.

There are several ways that this system could be segmented. Segmenting by fuel type could allow the system to promote a specific fuel type, while segmenting by ship segment could allow the system to encourage segment-specific decarbonization and avoid competition between segments. Segmenting by size could have the same impact as by segment, but from a size perspective.

This system aims to accelerate the decarbonization of the entire shipping industry, not just for specific segments or sizes. Therefore, the latter two options are not a good fit. Additionally, as mentioned in section 2.5.1, one of the advantages of using a CO₂e per MJ system unit is that it makes emissions comparable across vessel segments and sizes. Ship size or type does not impact token value, and tokens are only affected by fuel type.

However, the Book & Claim system will not drive decarbonization if conventional fossil fuels are allowed to swap with each other. Thus, this system will not allow swaps between conventional fuel types. The only swaps allowed will be between alternative and

conventional fuels, or amongst alternative fuels.³⁵ This segmentation may change as the supply of alternative fuels increases. As described below, any change to segmentation criteria should be approved by the system's general board and will be communicated and discussed prior to any changes.

In addition to the segmentation types listed above, participants may decide to limit their swapping activities within their specific companies or a group of companies. As all swapping is voluntary, this can be done without additional rules. Swaps between scope 1 and 3 tokens are also not allowed.

Creating segments may impact the normal functioning of the Book & Claim system. As a result, certain rules need to be put in place to ensure the traceability of the token. This includes:

- A rule that any segmentation should be approved by the general board. Any change in those rules is not retroactive,³⁶ and the corresponding adjustments in the registry shall be deployed in a reasonable time to allow actors to adapt to the new market rules.
- A rule that segmentation only applies to token transactions in the registry and does not affect the verification of emission-related data.
- A rule that, during the process of booking, the registry administrator (or the IT platform) shall identify the criteria included in the segmentation rules (e.g., type of fuel) to apply the corresponding actions in the registry (e.g., restrict swapping between tokens from voyages that used conventional fuel). Both rules and actions should be communicated to the tokens' owners.

³⁵ The definition of alternative fuels is as per [Industry Transition Strategy](#), Mærsk Mc-Kinney Møller Center for Zero Carbon Shipping, 2021

³⁶ This implies that the transaction made with previous segmentation rules will not be modified in any way. The new rules will be in force at the date established by the general board considering technical criteria and reducing the likelihood of potential disruption in the token exchange.



04

IT infrastructure



4. IT infrastructure

The section aims to describe some key elements of the platform that will support the Book & Claim system. Although it is too early in the system development process to delve into technical requirements and features, it is important to identify some platform functionalities required for the chain of custody and market rules discussed previously. In addition, this section outlines our initial attempts to establish criteria for evaluating different technologies or IT solutions based on the principles and objectives of the system, as well as the anticipated operational requirements to meet users' expectations.

This section on the potential platform's functionalities and criteria will be put into practice for the pilot as a simplified technological solution for testing key features and transactions (e.g., Minimum Viable Product). Based on the results from the pilot, a fully functioning platform will be released for testing and further engagement with key stakeholders.

4.1 Functionality and elements

The Book & Claim system requires a range of functionalities and elements to support Book & Claim transactions, including:

Figure 11: Possible structure and interaction of the modules in the IT platform.

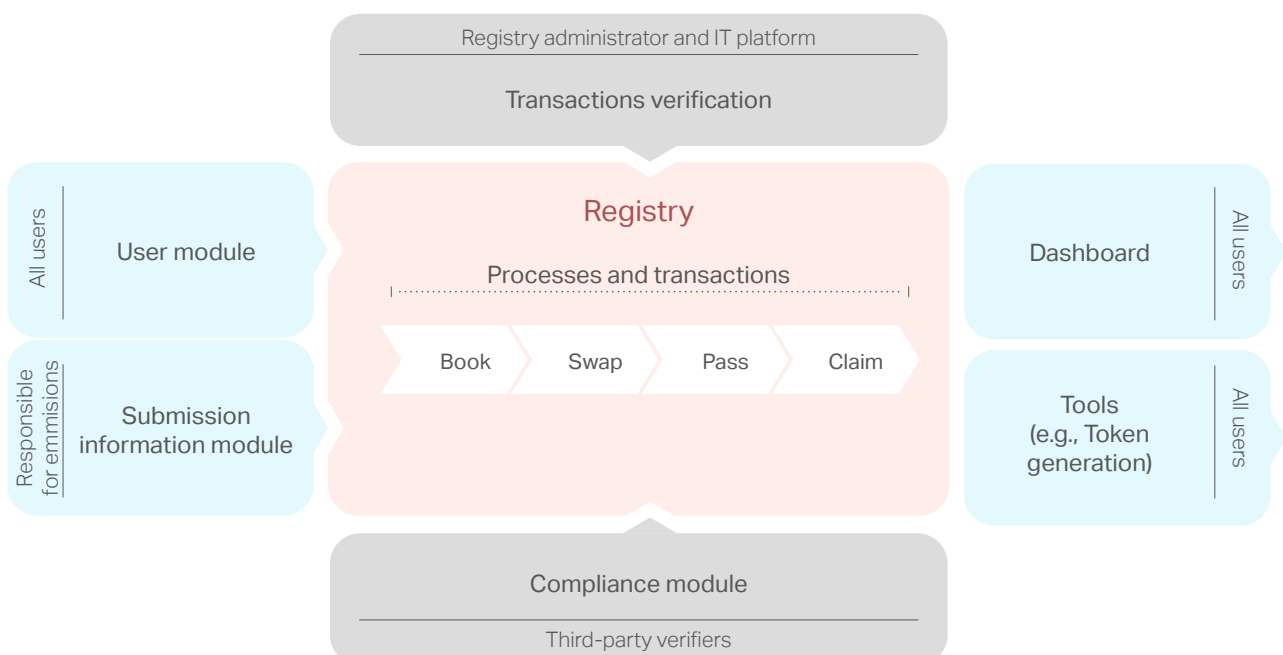

- **Registry:** A standardized database that enables the issuance, holding, exchange, and retirement of tokens.
- **User module:** This may include request forms for signing up to the platform and submitting required documents. It includes Know-Your-Customer³⁷ checks to facilitate and standardize the revision of the

criteria defined for each type of user. Once access is granted, the module allows users to visualize and modify their information (account management).³⁸

- **Information submission:**³⁹ This module is critical for user experience since it is the main contact point, along with the registry, between the users and

37 These checks are related to verifying the identity of users and assessing their risks of involvement in practices within the scope of anti-money laundering and counter-terrorism financing regulations.
 38 Changes that will have an impact on token ownership or transaction will likely require the approval of the registry administrator.
 39 This module will be essential for the intra-audit verification and aims to automatically identify inconsistency in the data submitted using attributes of the required data (e.g., type of data and value ranges) and, if it is available, the system's historical data and default values.



the Book & Claim system. Therefore, it should be intuitive and provide, for example, explanations of the structure of the data file and possible outcomes of the initial verification.

- **Token generation:** This optional module could allow users to check the number of tokens generated based on the information reported. Tokens may be grouped according to segments to facilitate swapping or claiming, depending on the portfolio's desired emission intensity.
- **Transaction verification:** The IT platform should enable the implementation of the verification points and rules for each transaction in the system, as described in section 3.
- **Compliance:** This module will allow third-party organizations to submit information about the initial and surveillance audits (dates, facility, process audited, potential non-conformities, and improvement plans subscribed, among others). Third-party organizations should also be able to submit a certificate of compliance or a document showing that the shipowner or operator complies with the system's requirements. The module will be linked to the 'information submission' module, which should only be activated once information has been submitted and checked for completion in the 'compliance' module.
- **Dashboard:** This module may have different views to show, for example users' token status, pending transactions, updates, and requests for additional information in case a token or transaction has been flagged during an inter-audit verification or risk-based verification. Another view may be populated with relevant data about market conditions (e.g., the number of fungible tokens per emission intensity or sorted by segment).

In addition, the IT platform should be built upon a robust architecture that ensures information security and data protection according to general-accepted standards and mandatory requirements such as the EU General Data Protection Regulation. In addition, the information assets should be clearly identified and classified to protect sensitive information declared by users (e.g., data with the label confidential).

4.2 Key features

There are several options for building the Book & Claim IT platform, including Excel, custom-built software, blockchain, etc. However, this technology choice will require more in-depth technical and economic analysis. Below are some key criteria to evaluate the convenience of possible solutions and to determine the cost structure for developing, maintaining, and updating the chosen solution:

- **Data architecture:** The platform should contain multiple databases while ensuring data integrity and accessibility.
- **Interoperability:** The protocols used for the platform should facilitate integration with third-party modules in ways that do not compromise the general security of the platform and data integrity.
- **Analytical capabilities:** The platform should include tools that support inter-audit verification (e.g., invalid data entries and cross-checking with default values) and improve users' decision-making (e.g., self-service reporting and dashboards).
- **Scalability:** The platform should be able to maintain the expected performance level amid periods of an increasing number of users, queries, and transactions. In addition, it should enable the development of applications or new modules on top of the registry and initial modules deployed.
- **Enhanced user experience:** The design of the modules and workflows in the platform should prioritize intuitiveness and user-friendliness.
- **Security by design:** The platform must protect critical information assets. Therefore, the processes of data storage and management, as well as system access, should include controls to mitigate tampering, and impersonation, among others.



05

Governance



5. Governance

This section provides the high-level structure of the governance rules and processes that should be in place to achieve our vision for the Book & Claim system to become a trusted, global platform for tracking and exchanging maritime GHG emissions. The governance of our proposed system is based on three pillars: a set of underlying principles, an overarching governance structure, and a robust verification framework. The underlying principles guide all governance decisions in the system, with the goal of generating trust and promoting accountability among roles and users. The governance structure materializes these principles in bodies and processes that ensure the system’s goals. Finally, the verification framework establishes the processes and definitions to bring the expected level of accuracy and transparency to the chain of custody and additional token transactions.

Regarding the scope of the governance, Figure 12 presents a simplified scheme with the actors and their material and financial flows. Obviously, the complexity of supply chains and operational and commercial models for shipping may exceed what is described in this document and, particularly, the rules and structure proposed in this section. Nevertheless, the figure is used for illustrative purposes to show what is considered in the system and what is out of scope. For example, financial flows are not considered in the governance structure and rules at this point. In addition, some key actors are not included explicitly in the system design. However, this does not diminish their importance in ensuring data accuracy (see section 2.1 on how participants should measure WTT emissions) and preventing double counting (see controls for double counting in Box 2).

Figure 12: Material and information flow into and out of the system.

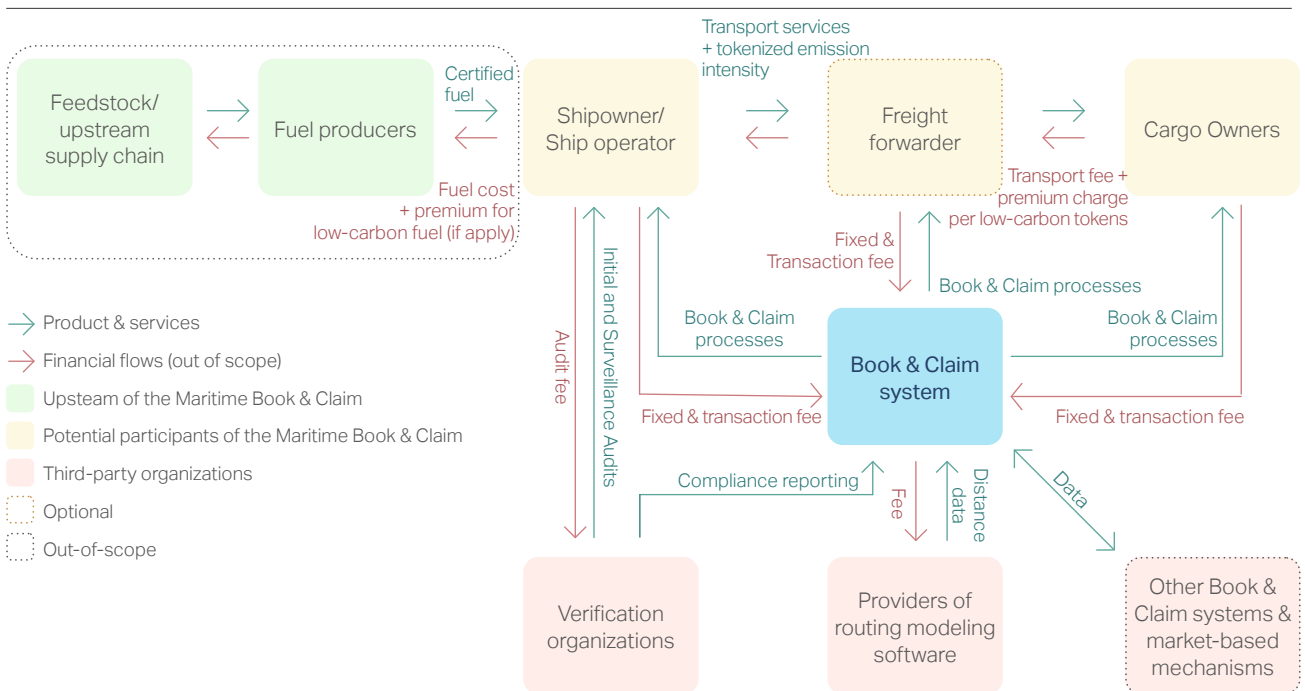

5.1 Principles

Our Book & Claim system design aims to support the decarbonization of the maritime sector by providing verified information about the GHG emission intensity of transportation services. Additionally, it also intends to facilitate the exchange of tokens

representing transportation services' emission intensity and other relevant attributes. To do so, the system relies on three principles described in Table 7: transparency, independence, and accuracy. All three are interdependent and contribute to the decision processes within the system and its interaction with external stakeholders.

Table 7: Description of the principles and how they are applied.

Principles	Description	How it is applied*
Independence	Each stage in the decision-making process includes checks and balances to mitigate the risk of outcomes that deviate from the general interests of the system's participants and the principles defined here.	<ul style="list-style-type: none"> - Committees are in place to separate the design of the guidelines from taking the decisions about, for example, changes in fuel emission factors, token exchange rules, granting access to the system, or recognizing a verification body. - The system's staff does not have any interference during the emission calculation process and should not request data besides what has been incorporated in the registry. - Committee members and registry staff must declare any potential conflict of interest. - GHG emission intensity calculations shall be verified by third-party organizations.
Transparency	All parties involved in the Book & Claim system will disclose the methodologies and data to ensure the consistency, accuracy, understandability, and comparability of the GHG emission measures used by the system's users.	<ul style="list-style-type: none"> - The guidelines described in sections 2 and 3 will be available online, and any changes go through a consultation process to ensure all relevant actors are included. - Anonymized data may be available for consultation by external stakeholders. - Information regarding GHG emission intensity and other relevant sustainability attributes from transportation services are shared in the system and support main features (e.g., tokens' value represents GHG emission intensity per unit of energy).
Accuracy	The data used for GHG intensity calculations and additional information requested during the token generation reflect the characteristics of the rendered service and are consistent with the methodologies proposed or approved.	<ul style="list-style-type: none"> - A multistage verification process, including third-party and automated controls in the technological platform supporting the registry and the token exchange, is utilized. - Quality checks are regularly deployed in the registry.

*This is not an exhaustive list; it is for illustrative purposes.



5.2 Structure

The governance structure (as shown in Figure 13) of the Book & Claim system aims to reflect the multistakeholder nature of any solution designed to decarbonize the maritime sector. The main governance body will be the 'general board', which comprises members representing relevant stakeholders from the maritime sector (e.g., shipowners, operators, organizations owning voluntary standards, fuel producers, fuel testing and certification bodies, business associations, and cargo owners). The 'Committee for Book & Claim Methodology' will support the general board and reviews the technical aspects of the system. This review will ensure that the principles of transparency and accuracy are followed when calculating the GHG emission intensity and transacting the tokens.

In addition, there will be ad hoc bodies such as the advisory board, whose members are not permanent and are selected based on the need for technical expertise in pertinent matters for the general board's decision-making. Similarly, the 'Committee for Alternative Fuels' will support the general board's decisions that may be impacted by regulatory and market development regarding alternative fuels. It is important to mention that the methodologies and the structure of the Book & Claim system are designed to be technology-agnostic. However, changes in engine technologies, alternative fuel production pathways, and vessel design and operations practices will be assessed by the ad hoc bodies to propose any necessary changes in methodologies and token exchange rules to achieve the system's vision.

Figure 13: Governance structure (roles and responsibilities).

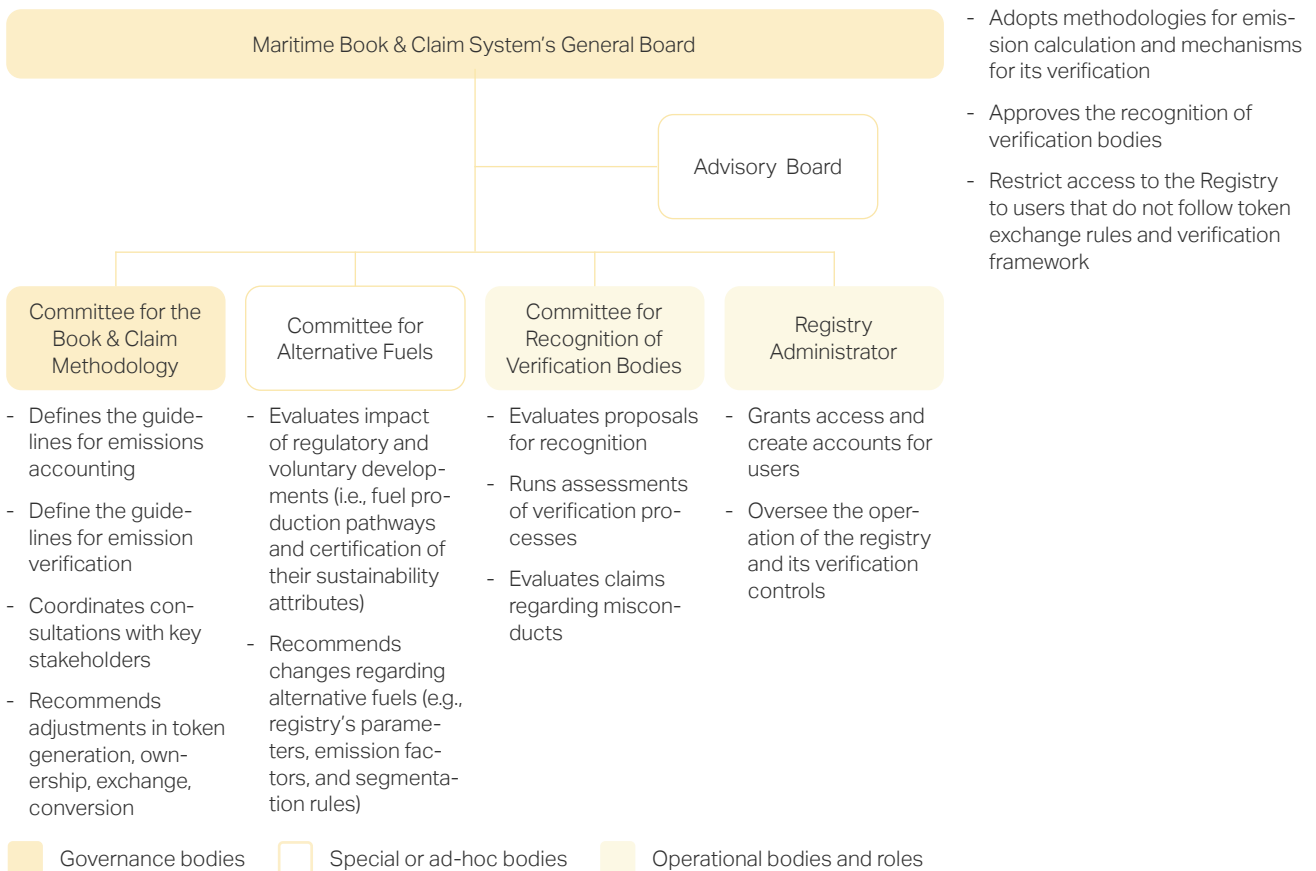

Furthermore, two additional roles will support the system: (i) the 'Committee for Recognition of Verification Bodies' and (ii) the Registry Administrator. The Committee for Recognition of Verification Bodies will be key to providing a transparent process for verification bodies and ensuring their competence and readiness to oversee the implementation and deployment of the proposed methodologies by users responsible for submitting emission and voyage-related data. The Registry Administrator will be the platform gatekeeper and ensure compliance with policies described in the previous sections regarding granting access to the registry and oversight of token transactions.

After the initial adoption of the methodologies to calculate GHG emission intensity and the platform pilots, the Committee for the Book & Claim Methodology will review all potential changes and recommend a decision regarding their adoption to the general board. The decision to adopt any changes should be considered with due reflection on the impact the change will have on the system's acceptance, the compatibility and alignment with regulatory and voluntary standards, and with the incorporation of feedback from key stakeholders. Those changes may include an adjustment in parameters for GHG emission intensity calculation (e.g., fuel certification, methods for calculating GHG emission intensity, default values for emissions in fuel transportation or engine efficiency, unit conversion) and guidelines regarding tokens (e.g., definitions, minimum information requirement, fungibility, and lifecycle of tokens).

Although the Committee for the Book & Claim Methodology may recommend changes in the methodologies at any time in the presence of unanticipated external factors, two situations may trigger an automatic methodology change:

- Changes in regulation and guidelines from the IMO (e.g., GHG emission lifecycle) or other key geographies (e.g., FuelEU Maritime Directive).
- Annual revision of parameters based on data available in the system (e.g., calibration of the parameters for token generation and fuel emission factors).

It is important to mention that, in alignment with the principle of transparency, any changes should include a multistakeholder engagement process. This process should at least involve identifying stakeholders that

may be impacted by the proposal, their interest in the proposal, and their potential influence on the market's acceptance of the proposed changes. Furthermore, the engagement should consider other developments in the maritime industry (e.g., emission accounting, lifecycle assessment, the chain of custody methods such as mass balance and Book & Claim systems) and the need for sector-wide articulation in key matters.

5.3 Verification framework

A robust verification framework will be required to ensure the accuracy and reliability of the data and transactions in the Book & Claim system. This framework will be an extension of the system's principles of independence and accuracy. It will provide the general concepts and structure of the verification activities and the boundaries of such activities (i.e., assessment objects and definition of the audit cycle).

Since Book & Claim decouples material flows, verification activities include the assessment of records or evidence regarding the fuel and voyage's main attributes (i.e., fuel certifications, in-situ audits, and compulsory documents related to the transportation service and fuel procurement) and transactional data in the registry showing token traceability (e.g., timestamps and changes in token ownership). Implementing such activities requires the involvement of multiple parts of the value chain aligned to different regulatory frameworks and climate-related voluntary standards. This presents several challenges:

- **Cost-effectiveness:** There is a tradeoff between increasing the number of verification points and creating a trusted system. This tension of having more trust at the cost of increasing the barriers to entry is a critical point that impacts both the system acceptance and the availability of reliable and timely data to support the transactions.
- **Administrative burden:** While some of the essential and additional data required by the system are also required by regulatory bodies and voluntary schemes such as GLEC, GHG-P, and SBTi (although in a higher frequency of reporting for the system), the Book & Claim system still requires additional data points. This creates an additional compliance burden for participants. The system's data requirements and its verification should be designed in a way that attempts to avoid this additional compliance burden.



- **Verification actions between audit cycle events:**
Usually, the time between audits ranges between 6 to 12 months. This is a period in which uncertainty around the validity of the token's information may affect market dynamics and require the further development of settlement mechanisms to resolve disputes and claims around the validity of historical transactions made with tokens already claimed.

These challenges are exacerbated by the fact that verification methods,⁴⁰ expected outputs,⁴¹ and assurance levels⁴² vary among assessment objects. The framework outlined in Table 8 intends to deal with these challenges by minimizing administrative burdens and costs while still ensuring sufficient verification actions between audit cycles. The framework covers three assessment objects across five verification activities.

Table 8: Verification framework.

Assessment object	Verification activities				
	Initial verification for access granting	Initial audits*	Inter-audits verification	Surveillance audits*	Risk-based verifications
Users	Application of KYC policies Additional criteria per type of user (e.g., collaterals)	Validation of processes for emission intensity calculation and data management		Verification of consistency of the processes with the system's rules	
Emission and voyage-related data		Verification of calculation for first batch of voyages to be booked.	Cross-check information required (minimum and additional) for token generation	Verification of emission intensity calculation of voyages booked into the registry	Cross-check emissions intensity values and voyage information with historical data and default values
Transactions			Verification of token transactions according to the registry rules		Verification of market dynamics and identification of potential deviation from the system's rules
Responsible	Registry administrator	Third-party verifier	Registry administrator and automated controls	Third-party verifier	Registry administrator and automated controls

* This verification applies for users who are able permanently or temporally to generate tokens.

40 Verification methods may include in-situ audits to review records on how users are implementing the methodologies for emission calculation, for example.

41 Some of the verification activities presented in the table have different outcomes; for example, the outcome of the initial validation for users is the access to the system, whilst the initial audit's outcome is to allow users' voyage data being translated into tokens and recorded into the registry.

42 In the methodology for calculating WTT emissions, there are several options to determine those emissions from using primary data from trusted sources (i.e., fuel certificate) to secondary data (i.e., emission factors). This impact assurance level that can be obtained, even after running an audit cycle.



The section below describes the elements of the framework beginning with how the assessment objects are verified:

- **Users:** There are several roles (or accounts) within the Book & Claim system, as described in section 3.1. Each role has associated requirements for participation in the registry and generating, passing, swapping, and claiming tokens. User verification focuses on determining if a user complies with the criteria to access the system, and with the processes for determining voyage characteristics (including emission intensity) according to the methodologies described in section 2. It also validates if the processes for determining voyage characteristics are implemented consistently through time, for example, through surveillance audits.
- **Emission and voyage-related data:** Verification of emission data aims to ensure that the right formulas, parameters, assumptions, and guidelines are being applied in the correct manner to ensure a comprehensive and reasonable assessment of emission intensity from transportation services. The data required for the calculation of emission intensity per voyage is described in section 3.
- **Transaction:** The platform that supports the registry and token exchange should incorporate sufficient controls to ensure token traceability (e.g., identity, value, labels, timestamps, etc.) and to avoid double accounting. Once similar initiatives mature, shared databases or clearing houses can be incorporated into the verification framework to prevent using one voyage to generate tokens or credits in multiple platforms. The scope of this verification is defined in section 3.

Details regarding the verification activities are described below:⁴³

- **Initial verification for access granting:** This verification will apply to all the users that want to be included in the system, and may incorporate additional requirements for certain types of users to ensure transparency and trust in the token exchanges (e.g., verification if the user is under investigation, or has been convicted, for fraud, money laundering, terrorist financing or other serious crimes). This verification will follow the guidelines presented in section 3.1 that describe the specifics for granting or denying access to the system.
- **Initial audit:** For the initial audit, a third-party organization (aka verifier) recognized by the general board will validate that the shipowners' GHG emission intensity calculation complies with the guidelines established in section 2. Furthermore, the organization will verify the calculation of GHG emission intensity made by the shipowners or operators from the voyages for inclusion in the registry. This will be according to the guidelines defined by the Committee for the Book & Claim Methodology regarding the audit scope (e.g., which period will be considered). After successfully completing this initial audit, the recognized verifier may issue a certificate of compliance or a document showing that the shipowner or operator complies with the system's requirements regarding GHG emission intensity calculations and additional policies on data management. This document will be required to generate tokens into the system and to claim scope 1 tokens.
- **Surveillance audits:** Surveillance audits will be shorter than initial audits and focus on evaluating consistency in applying the methodologies for calculating GHG emission intensity. To do so, the verifier may use a randomized verification of voyages that were included in the registry within the scope of the audit. The general board will define the frequency and duration of the surveillance audits according to technical and economic factors. Furthermore, this kind of audit will also be triggered as a response to a risk-based assessment driven by analysis of data related to emissions, token transactions, and voyages' characteristics.
- **Inter-audits verification:** This verification will use default values, third-party databases, and the system's historical data, among other sources, to set automatic controls to detect inconsistencies in the data (potential outliers, data tampering) that require additional verification. This information will also be brought to attention in the audit cycle to ensure an action plan is implemented to take corrective

⁴³ The detailed explanation of the data requirements and specific method of verification for emission-related data and transaction is presented in section 3.



action and close any non-conformities. Regarding transactions, the platform will verify the information of each stage in the token's lifecycle, particularly its embedded critical data (i.e., token value, issuers' information, voyage data, and changes in ownership). In addition, controls will be implemented to avoid using data from a specific voyage to generate tokens in different platforms and claim its sustainability attributes (including the emission intensity) in other Book & Claim systems.

- **Risk-based verification:** Besides the previous activities, the system will require verification that combines data from different assessment objects to identify potential deviations from the system's rules using historical data, default values, and benchmark values generated by specialized analytical software (e.g., AIS, weather routing software). The results

of this verification may modify the audit cycle by reducing the time between audits. Also, it may trigger changes in the system's methodologies and token exchange rules to mitigate risks associated with data that do not reflect the shipping segment, vessel, and voyage. Furthermore, this verification aims to identify practices that may affect the data's level of assurance and the trust in the Book & Claim system. For example, consistent misreporting of data, data tampering between an audit and the submission of the voyage's data, lack of actions to close non-conformities, and practices that hinder the verification process. If there is reasonable doubt or evidence that a user has participated in these practices, the registry administrator will report the situation along with the evidence to the general board to take the corresponding measures.



Box 2: Double counting

In general terms, double counting happens when two different organizations claim the same environmental attributes.⁴⁴ Avoiding this situation is critical to ensure trust in the system. Therefore, we have proposed several approaches that may mitigate the risk of double counting through the whole process from the emission and voyage data collection to the token transaction (i.e., token claiming).

It is important to clarify that not all double claiming is the same, and thus it doesn't have the same effect on the system's outputs. It also depends on the role and the scope of the emission. According to GHG-P,⁴⁵ scope 1 emissions are only owned by the company responsible for them. However,

indirect emissions such as electricity purchased (scope 2) and fuel's upstream emissions (scope 3) are already counted by other companies as scope 1. Scope 3 emissions are, in fact, double counted multiple times by different organizations through a supply chain, upstream and downstream. The more complicated a supply chain is, the more times the same specific emissions are counted as scope 3 of organizations.

Industry-specific GHG reporting frameworks (such as the GLEC and the upcoming ISO 14083) aim to reduce uncertainties in GHG accounting. Also, upcoming legislation (such as U.S. Securities and Exchange Commission's proposed rules to enhance and standardize climate-related disclosures for investors) may offer more guidance on scope 3 GHG reporting.⁴⁶ For more detailed explanations of emission allocation rules, please refer to section 3.2.2.

44 [Double Counting](#), United States Environmental Protection Agency

45 [Corporate Value Chain \(Scope 3\) Accounting and Reporting Standard](#), Greenhouse Gas Protocol

46 [SEC Proposes Rules to Enhance and Standardize Climate-Related Disclosures for Investors](#), United States Securities and Exchange Commission, 2022

Table 9: Typology of double counting.

Type of double counting ⁴⁷	Description	Control/policy
Double issuance	<p>Occurs when two or more tokens are issued based on the same voyage information.</p> <p>Example:</p> <ul style="list-style-type: none"> - The shipowner and operator booked emission data from the same voyage at different times. - A Stranded owner booked emission data from a voyage, which is later booked for the shipowner or operator who rendered the service. 	<p>The key issue is the lack of agreement on who owns the emissions from a voyage based on the commercial agreement. The following policies and controls are in place:</p> <ul style="list-style-type: none"> - Allocation policies (section 3.2.2) - Verification control of double booking in the platform (section 3.2.1) - Time limits for booking data from a voyage (section 3.3) - Verification activities: Inter-audit verification and Risk-based verification (section 5.3)
Double claiming	<p>Occurs if a token is claimed more than once by two or more users through token's lifecycle.</p> <p>Examples:</p> <ul style="list-style-type: none"> - More than one shipowner, ship operator, forwarder, or cargo owner claim a token's emission intensity generated by the same piece of transport activity or the same part of the same piece of transport activity 	<p>The key issue is the definition of the type of role and emissions involved in the transaction. The following policies and controls are in place:</p> <ul style="list-style-type: none"> - Definition of roles and interaction through value chain (section 3.1) - Rule defining that tokens are not allowed to be claimed twice by participants with the same role (section 3.2.3) - Platform's control during the claiming process (section 3.2.3) - Verification activities: Inter-audit verification and Risk-based verification (section 5.3)
Double use	<p>Occurs when a user utilizes the emission-related data from a voyage booked in the system to also obtain tokens, credits, certificates, or other benefits in another market-based mechanism.</p> <p>Examples:</p> <ul style="list-style-type: none"> - Shipowner or operators use the emission from a voyage in another Book & Claim system to monetize twice the voyage's emission intensity. - Shipowner or operators use proprietary mechanisms to monetize sustainability attributes (include emission intensity) with their clients, and then use this information to book the same voyages in our System. - Shipowner or operators use token's emission intensity data to claim emission reductions against a baseline established in the another Book & Claim system. 	<p>This is explicitly prohibited for the participants of the system. The following policies and controls are in place:</p> <ul style="list-style-type: none"> - Legal document and criteria to gain access to the system (section 3.1) - Risk-based verification (section 5.3) - Restriction of access to the system and further measures related to tokens owned by the user involved in this practice (section 5.2) <p>In addition, the system will be designed to facilitate communication and auditing in alignment with other market-based mechanism to prevent this practice.</p>
Double purpose	<p>Occurs when a shipowner or operator do not discount properly emission reductions aiming to comply with regulations (i.e., blended mandates or cap and trade mechanism). This is related to concept of additionality.</p> <p>Examples:</p> <ul style="list-style-type: none"> - Shipowner or operators use voyage's emissions reduction for complying with environmental regulation and at the same time monetize such reduction in a market-based mechanism such as a Book & Claim system. 	<p>By design the system does not consider this type of double accounting. For a detailed discussion about additionality, please refer to box 1.</p>

47 Based on the typology defined in [Addressing the risk of double counting emission reductions under the UNFCCC](#), Stockholm Environment Institute, 2014

06
System
acceptance



6. System acceptance

This chapter aims to identify the main regulatory and voluntary initiatives that may impact the acceptance of our Book & Claim system. It presents the main points of convergence and dissonance between the system proposed and those initiatives from a GHG emission accounting, monitoring, and reporting perspective. Understanding the regulatory and voluntary landscape will help to set a common framework of concepts and measures to assess GHG emission intensity without increasing the compliance burden on the system's participants. It can also facilitate future engagement with key stakeholders, such as regulators and owners of voluntary schemes for emission accounting, reporting, and certification matters.

6.1 Regulators

This section outlines some of the regulatory frameworks and requirements for assessing and reducing GHG emissions in the maritime industry. Although several regional and national-level developments exist in this area, this subsection focuses on regulations from the IMO and the EU. Both the IMO and the EU have developed their regulations and GHG emission measurement methodologies to support

their goals of reducing the average carbon intensity of all ships by at least 50% in 2050, compared to 2008's values,⁴⁸ and reducing net emissions by at least 55% by 2030, compared to 1990,⁴⁹ respectively. IMO and EU regulations are technology-agnostic, establish high-level guidelines to avoid market distortions (e.g., choosing a preferred low-carbon fuel), and encourage cost-effective solutions to decarbonize the sector. This flexibility is important, as not all alternative fuels and propulsion systems have reached commercial scale or enough maturity to be deployed for all vessels. However, this presents a challenge since the IMO, the EU, and other regulatory bodies will need to develop regulations, standards, and guidelines for alternative fuels and for determining how market-based mechanisms such as a Book & Claim system can be used to account for compliance purposes. As a result, the governance structure of our Book & Claim system will include a 'Committee for Alternative Fuels' to monitor such developments and propose required changes to the system's methodologies and rules.

Although a Book & Claim system is not a compliance tool, aligning with the regulatory bodies' approaches to calculating emissions of maritime transportation services is essential to improve the system's acceptance by ensuring that the administrative burden of collecting and processing data is reduced. Table 10 presents the four main criteria for approaching emissions calculation.

Table 10: General overview of main emission-related criteria.

	IMO ⁵⁰	EU Regulation	Proposal for our Book & Claim system
Type of emissions	CO ₂	CO ₂ , CH ₄ , N ₂ O	CO ₂ , CH ₄ , N ₂ O
Scope of the emissions	TTW	WTW	WTW
Units to measure emission intensity	CO ₂ /tnm	CO ₂ eq/MJ	CO ₂ eq/MJ
Subject of compliance	5,000 gross tonnage	5,000 gross tonnage	5,000 gross tonnage

48 [IMO's work to cut GHG emissions from ships](#), International Maritime Organization

49 [FuelEU Maritime Proposal for a REGULATION OF THE EUROPEAN PARLIAMENT AND OF THE COUNCIL on the use of renewable and low-carbon fuels in maritime transport and amending Directive 2009/16/EC](#), European Union

50 Annex 1 presents detailed information about the energy efficiency measures established by IMO.



Although the IMO currently only includes CO₂ emissions from a TTW perspective in their emissions criteria, upcoming guidelines are expected to consider additional GHG from a WTW perspective. EU regulations have been designed to converge with the IMO's proposed guidelines and include CO₂, CH₄, and N₂O. The FuelEU Maritime⁵¹ directive also proposes a WTW approach. Similarly, our Book & Claim system will include CO₂, CH₄, and N₂O emissions from a WTW perspective.

The main difference between IMO and EU regulations is the units used in emission calculations. The EU is opting for CO₂eq emissions per energy-based units (i.e., CO₂eq/MJ) to evaluate the vessel-level performance against the reference values and to articulate the requirements, incentives, and other policies for decarbonizing the maritime industry. On the other hand, IMO's current measures, such as CII, use transport activity-related units (e.g., CO₂/tnm), and its forthcoming guidelines for fuel emissions will use energy-based units (i.e., CO₂eq/MJ). Although our proposed Book & Claim system will use energy-based units (i.e., CO₂eq/MJ) for the token's value, voyage information might be accessed in the token's data to calculate transport activity. This will allow for easier alignment with IMO current measures and voluntary schemes such as GLEC. The system will also align with the IMO and EU on restricting assessments to vessels above a 5,000 gross tonnage.

It is important to note that, for the EU ETS, intra-EU voyages include all the energy used during the voyage, but only half of the energy is considered in scope on voyages to ports outside of EU members' jurisdictions.⁵² This may have implications when token claimers want to use the emission intensity for reporting purposes. To mitigate this possible burden, information about the voyage, particularly whether ports of call are under EU jurisdiction, will be requested when the token is generated.

Regarding the responsibility for reporting information, the EU and IMO have established that those responsible for compliance with their regulation are

the shipping companies, which are defined as 'the ship-owner or any other organization or person, such as the manager or the bareboat charterer, that has assumed the responsibility for the operation of the ship from the ship-owner and that, on assuming such responsibility, has agreed to take over all the duties and responsibilities imposed by the International Management Code for the Safe Operation of Ships and for Pollution Prevention.'⁵³ As previously mentioned, companies are obligated to report once per year (e.g., by April 30 of each year in the case of the EU) under both regulations.

The verification process of the information provided by the shipping companies differs across the IMO, EU, and Book & Claim system proposals, for example who is responsible for the verification, and how this organization is recognized or accredited. To comply with IMO regulations, shipping companies must submit information to vessels' flag administrators or recognized organizations to verify the data according to the requirements of the fuel Data Collection System (DCS). In contrast, the FuelEU Maritime proposal establishes that shipping companies shall obtain a 'FuelEU certificate of compliance' issued by an accredited verifier, confirming that a specific ship complied with this regulation over a specific period.⁵⁴ Our Book & Claim system will use a multistage verification process, in which a third party validates the application of the GHG emission intensity calculation run by the shipping companies before triggering the process of token generation. These verifiers then execute regular audits of the calculation process to ensure data accuracy and reliability. In addition, the technological platform will also verify transactions based on token nature and status, type of users, and the system's rules.

Finally, IMO and EU regulations do not explicitly mention using Book & Claim systems as mechanisms to comply with or support decarbonization goals. However, there is a symbiotic relationship between regulatory and market-based mechanisms like Book & Claim systems, which can play an important role in helping achieve decarbonization targets and complying with regulations

⁵¹ It is important to note that FuelEU is part of a package of major changes that also include suggested modifications to existing EU directives such as RED II, EU MRV, and EU ETS. One of the changes promoted by the FuelEU directive is the inclusion of the maritime sector in the EU ETS, and is likely to have a significant impact by encouraging an accelerated adoption of technologies and mechanisms to reduce emissions.

⁵² FuelEU Maritime [Proposal for a REGULATION OF THE EUROPEAN PARLIAMENT AND OF THE COUNCIL on the use of renewable and low-carbon fuels in maritime transport and amending Directive 2009/16/EC](#), European Union

⁵³ [FuelEU Maritime – Sustainable maritime fuels](#), European Parliament, 2022

⁵⁴ It is important to clarify that the accreditation process of the companies acting as verifiers shall follow the rules of the regulations (EC) No 765/2008 and FuelEU Maritime.



such as the FuelEU Maritime Directive. Therefore, a mechanism like a Book & Claim system should evolve with regulatory developments to fully capture changes in market dynamics and decarbonization paths proposed by regulators. In the same way, regulatory bodies and governments such as the IMO or EU should monitor the evolution of market-based mechanisms to use them as a catalyst for reaching decarbonization goals without generating market distortion, compliance burden, and negative impact on industry competitiveness.⁵⁵

6.2 Accounting and reporting

Our Book & Claim system must align with accounting and reporting schemes or standards to facilitate adoption and create a common language that enables interactions (which might include transactions) between the system's users and other stakeholders outside the

system. Furthermore, reliable and accurate emission accounting is the bedrock for building trust among users and for leveraging their efforts in order to achieve efficient and timely sectoral decarbonization goals.

This subchapter aims to briefly describe the main elements of the most widely accepted voluntary schemes for emission accounting and reporting. These schemes share some principles and calculation approaches. There are, however, some differences in how emissions are accounted for and calculated, which are presented in Table 11. It is important to clarify that the schemes shown in Table 11 meet different purposes ('Type of scheme'). Some schemes provide the framework to define, calculate, and report emissions (i.e., GHG-P, GLEC, and ISO 14083), while others aim to determine to what extent companies' emissions are aligned to fixed emission trajectories in the long term (i.e., Sea Cargo Charter and SBTi).

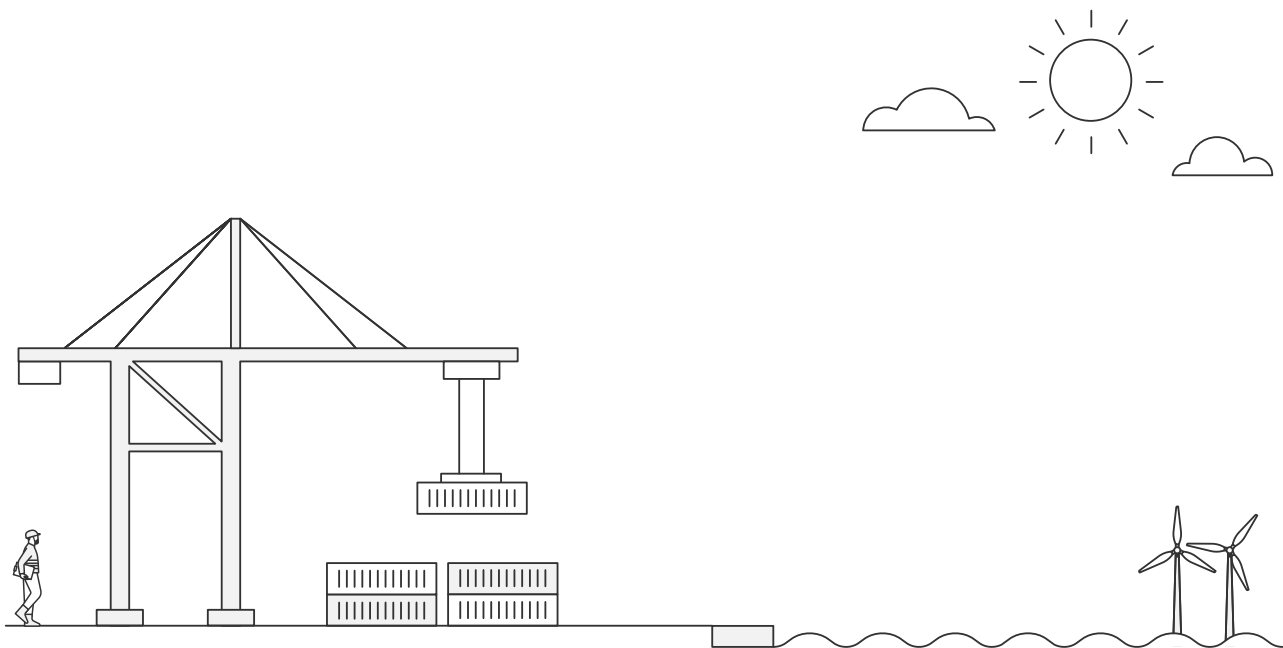

⁵⁵ The sustainable aviation fuel Book & Claim system is an example of how a Book & Claim system can be used as a flexible mechanism to reach the goals and comply with the requirements of the ReFuelEU Aviation proposal in the most cost-effective manner.



Table 11: Comparison of voluntary standards for accounting and reporting emissions from marine transportation.

	GHG-P ⁵⁶	GLEC ⁵⁷	SCC ⁵⁸	SBTi Maritime ⁵⁹	Proposal for our Book & Claim system
Type of scheme	General framework for emission calculation	Specialized framework for freight emissions	Maritime climate-alignment framework	Maritime climate-alignment framework	N/A
Emissions	CO ₂ , CH ₄ , N ₂ O, HFCs, PCFs, and SF ₆	CO ₂ , CH ₄ , N ₂ O, HFCs, PCFs, SF ₆ , NF ₃ , and black carbon	CO ₂ ⁶⁰	CO ₂ , N ₂ O and CH ₄	CO ₂ , CH ₄ , N ₂ O
Lifecycle	WTW (if reporter considers all scopes) ⁶¹	WTW	TTW	WTW	WTW
Calculation	The emissions are calculated using fuel consumption data multiplied by documented fuel emission factors. This should be done for each GHG and then converted into CO ₂ eq units.	The emission intensity is calculated using fuel consumption data and emission factors provided in the framework. Then, divided the emissions into the transport activity (using weight and distance of the services rendered).	SCC uses IMO's Energy Efficiency Operating Indicator (EEOI) to measure carbon intensity. This is then compared against a 'theoretical' decarbonization path based on IMO's goals to determine signatories' climate alignment.	SBTi uses EEOI and GLEC's emission factors to calculate emission intensity, which is later compared with a 1.5°C trajectory based on sectoral carbon budget allocation and projected maritime transport demand.	The emissions intensity is calculated using primary fuel consumption data and direct emission measurements. For detailed description, please see section 2.1
Units	tCO ₂ eq	kgCO ₂ eq/tkm	tCO ₂ /tnm	gCO ₂ eq/tnm	gCO ₂ eq/MJ
Verification	Internal independent audits or third-party verification	Third-party verification	Internal independent audits or third-party verification	Both targets and emission information are validated by the SBTi team and may be verified by third-party organizations.	Multistage process described in the verification framework including third-party verification and in-house controls (IT platform and Registry administrator)

Our proposed Book & Claim system will incorporate several elements from the mentioned voluntary schemes, since some are referents for the industry and enable a common language between the system and the ecosystem around the decarbonization of the maritime industry. Those elements come mainly from two key schemes: GHG-P and GLEC. GHG-P is one of the most widely adopted emission accounting and reporting schemes across industries, and GLEC is a specialized framework for multi-modal logistic services built upon GHG-P main concepts and approaches.

Regarding how the emissions are approached and calculated, in general, the emissions considered by our system are also included by the other schemes, and the emission lifecycle approach is the same (WTW). For schemes that calculate emission intensity, the parameters used are similar (total emissions), but they differ by way of the denominator. GLEC, SCC, and SBTi use transport activity, while our proposed system uses energy consumption to determine energy intensity per megajoule (MJ). Nevertheless, the system will require the information to calculate transport activity, which

⁵⁶ [REGULATION \(EU\) 2015/757 OF THE EUROPEAN PARLIAMENT AND OF THE COUNCIL](#), European Union, 2015

⁵⁷ [Implement the GLEC Framework](#), Smart Freight Centre

⁵⁸ [Sea Cargo Charter](#), Sea Cargo Charter

⁵⁹ [Science based target setting for the maritime transport sector](#), Science Based Targets, 2022

⁶⁰ The latest SCC framework version states that other gases will be included once the IMO releases its lifecycle guidelines for marine fuels.

⁶¹ For example, a shipowner may report emissions from fuel combustion (as scope 1) and the emissions from fuel production (including feedstocks) and its transportation (as scope 3).



will allow users to convert the token's value to carbon intensity per transport activity unit (e.g., gCO₂/tkm).

One of the key topics across the schemes is the determination of who owns each type of emissions. Both GHP-P and GLEC consider two approaches to accounting for scope 1 and 3 emissions, namely equity share and control, which aim to reflect the 'substance and economic reality' of the reporting company and provide sufficient data to enable the company and its stakeholders' decision-making.⁶⁴ The other two schemes, particularly SCC, elaborate on that to provide more clarity on certain types of contracts (e.g., time and bareboat charters). More details about these definitions, along with our system's approach regarding how to allocate the emissions, can be found in section 3.2.2.

Another critical component is the type of measurement and data source accepted for calculating emissions intensity. The schemes used for comparison accept direct measurement and the use of emission factors⁶⁵ for quantifying emissions and calculating emission intensity. Similarly, our Book & Claim system will require primary data for key variables in calculating WTW emissions (e.g., for fuel consumption). In addition, section 2.1 takes a step further and defines the sources and methods that meet the accuracy level required for the system regarding the emission and transport activity data. On the other hand, the voluntary schemes referenced in this section use some type of baseline or base year to calculate emission reductions, or to what extent emissions are aligned with a specific emission trajectory. For example, GHG-P uses the

first year of verifiable emissions data as a baseline for further goal setting and calculating emission-reduction activities. In the case of our Book & Claim system, this is a significant point of departure from other schemes since there is no baseline or base year. This system feature provides flexibility in companies' GHG emission reporting by allowing companies to use the tokens' information in combination with their industry or organization-level baseline to report emission reductions. As a result, emission intensities captured in tokens are not exchanged as reductions from baselines, but in actual emission intensities.

One scheme not included in the comparison was the new ISO 14083 for quantification and reporting of GHG emissions arising from transport chain operations. This standard is a significant step in harmonizing concepts and methodologies for calculating and reporting emissions from freight transportation and logistics. ISO 14083 was released in March 2023. Therefore, how other voluntary schemes will adopt or consider its concepts and guidelines is unclear. The standard covers all modes of transport (land, water, air) and includes guidelines on how to calculate operational emissions for transport hubs and for empty trips required for the transportation of freight or passengers.⁶⁴ ISO 14083 was designed to be aligned with other ISO standards such as ISO 14064 series,⁶⁵ ISO 14067,⁶⁶ ISO 14040,⁶⁷ and ISO 14044.⁶⁸ Likewise, the standard is aligned with widely used emissions accounting and reporting schemes such as GHG-P and the GLEC Framework.⁶⁹

62 [Implement the GLEC Framework](#), Smart Freight Centre

63 GLEC provides the CO₂eq emission factors for both the WTT and TTW phases for a range of marine fuels. Those factors are used in other schemes, such as SBTi. However, our system will use emission factors from FuelEU directive (see section 2.1 for a detailed explanation).

64 [ISO 14083:2023 Greenhouse gases — Quantification and reporting of greenhouse gas emissions arising from transport chain operations](#), ISO

65 It consists of three parts: [ISO 14064-1 Specification with guidance at the organization level for quantification and reporting of GHG emissions and removals](#); [ISO 14064-2 Specification with guidance at the project level for quantification, monitoring and reporting of GHG emission reductions or removal enhancements](#); and [ISO 14064-3 Specification with guidance for the verification and validation of GHG statements](#).

66 [ISO 14067:2018 Greenhouse gases — Carbon footprint of products — Requirements and guidelines for quantification](#), ISO

67 [ISO 14040:2006 Environmental management — Life cycle assessment — Principles and framework](#), ISO

68 [ISO 14044:2006 Environmental management — Life cycle assessment — Requirements and guidelines](#), ISO

69 [ISO 14083:2023 Greenhouse gases — Quantification and reporting of greenhouse gas emissions arising from transport chain operations](#), ISO



07

Conclusion



7. Conclusion

Designing a Book & Claim system for the maritime industry requires many considerations, including how best to measure data, how exchanges of that data should be structured, what IT infrastructure is needed, how governance should be structured, and how external authorities will view the decisions taken. These factors must be considered before a pilot can commence. However, the pilot will likely lead to unexpected outcomes and require additional design changes.

The Book & Claim system outlined in this paper is the result of extensive discussions with different stakeholders in the maritime industry. No design work completed before the pilot is final, and revisions to this design may occur up to and during a pilot. Our design is centered around making the most credible Book & Claim system possible so that the maritime industry has a new tool to help reduce GHG emissions.

If you have any feedback or comments to this paper, or the '[Maritime Book & Claim: System Overview](#)' paper, please fill in the survey included in this [link](#).

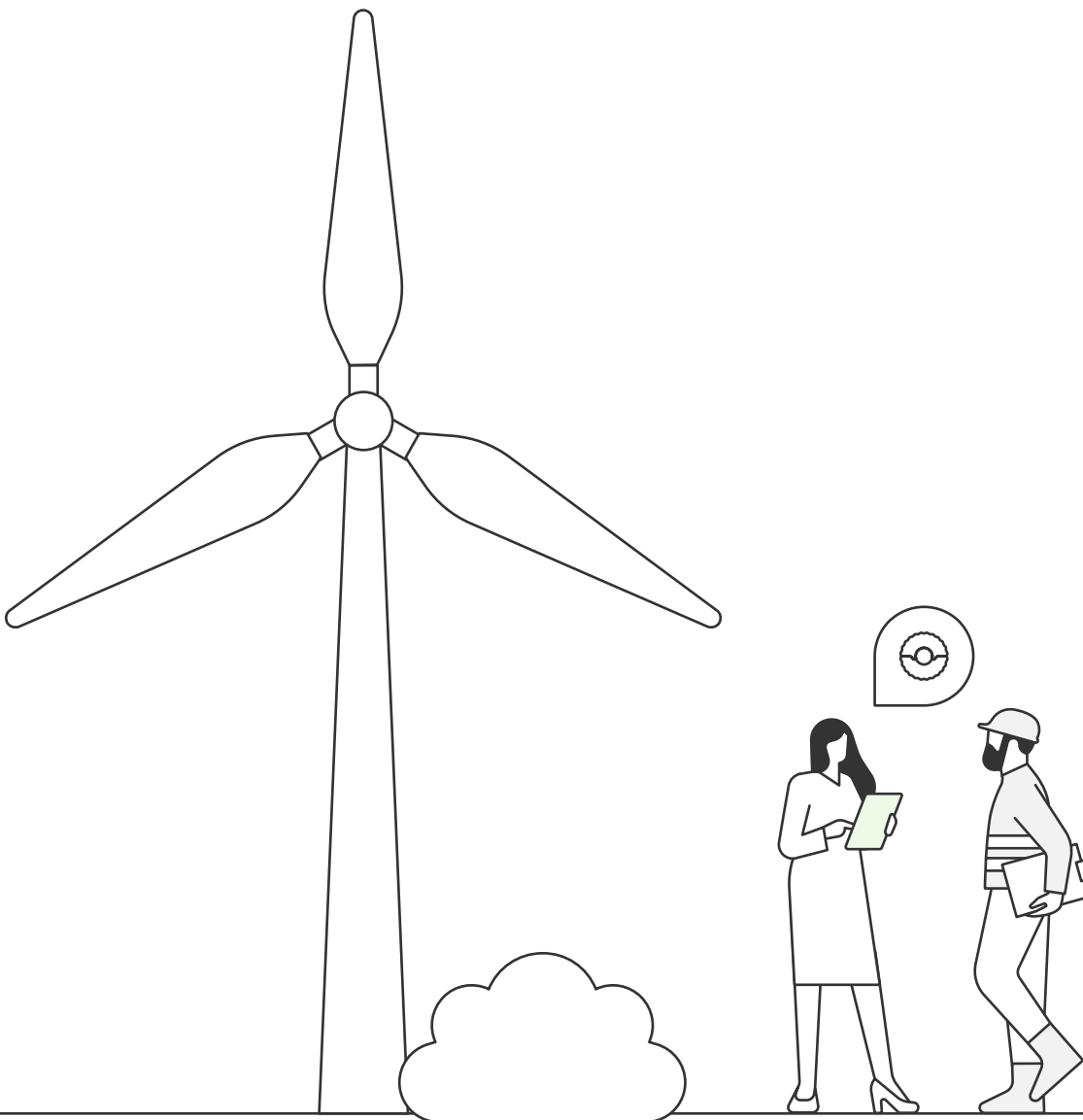

08

Abbreviations and Glossary



Abbreviations

AIS	Automatic Identification System
B/L	Bill of lading
CDP	Carbon Disclosure Project
CH ₄	Methane
CII	Carbon Intensity Index
CO ₂	Carbon dioxide
DOC	Document of compliance
ECDIS	Electronic Chart Display and Information System
EEDI	Energy Efficiency Design Index
EEOI	Energy Efficiency Operating Indicator
EEXI	Energy Efficiency Existing Ship Index
EU MRV	European Union Monitoring, Reporting and Verification
GLEC	Global Logistics Emissions Council
GHG	Greenhouse gas
GHG-P	Greenhouse Gas Protocol
GWP	Global warming potential
GSIS	Global Integrated Shipping Information System
IMO	International Maritime Organization
IMO DCS	International Maritime Organization Data Collection System
LCA	Lifecycle assessment
LHV	Lower heating value
ISO	International Organization for Standardization
N ₂ O	Nitrous oxide
SBTi	Science Based Targets Initiative
SDA	Sectoral decarbonization approach
TTW	Tank-to-wake
UMAS	University Maritime Advisory Services
VGM	Verified gross mass
WTT	Well-to-tank
WTW	Well-to-wake
g	Gram
CO ₂ eq	Carbon dioxide equivalent
KM	Kilometer
MJ	Megajoule
SAF	Sustainable Aviation Fuel
SAF _c	Sustainable Aviation Fuel certificate



System-related definitions

Assessment object

Also known as 'object of conformity assessment' in some ISO standards.⁷⁰ It refers to the items that will be assessed. These items may include, but are not limited to, information about the nature of the users, fuel consumption, type of fuel, specification of fuel's feedstock, type of vessel, token ownership, and token fungibility.

Audit

Defined as the 'process for obtaining relevant information about an object of conformity assessment and evaluating it objectively to determine the extent to which specified requirements are fulfilled.'⁷¹

Book & Claim

Chain of custody model in which the administrative record flow is not necessarily connected to the physical flow of material or product throughout the supply chain.⁷²

Booking

Process of registering and converting qualified information describing certain maritime transport activity and related GHG emissions into fungible tokens on the Book & Claim platform.

Claiming

Process of rendering the tokens nonfungible so that the nonfungible tokens can be used for reporting purposes. A participant will give up the right to exchange the tokens by claiming.

Certification

Provision by an independent body of written assurance (a certificate) that the product, service, or system meets specific requirements. Formal attestation or confirmation of certain object, person, or organization characteristics.

Chain of custody

Process by which inputs and outputs and associated information are transferred, monitored, and controlled as they move through each step in the relevant supply chain.⁷²

Chain of custody model

Approach to control inputs and outputs and associated information in a particular chain of custody system.⁷² A chain of custody system is a set of measures designed to implement a chain of custody, including documentation of these measures.⁷²

Verification Criteria

Defined as any procedure, rule, requirement, conversion or emission factor, default value, or benchmark value.⁷³ These are used as a reference to assess users' processes, data, or documentation related to token transactions (including the steps previous to the token generation such as emission intensity calculation).

⁷⁰ ISO 17000:2020 defines it as the 'entity to which specified requirements apply. [For example] Product, process, service, system, installation, project, data, design, material, claim, person, body or organization, or any combination thereof.'

⁷¹ [ISO 14064-3:2019 Greenhouse gases — Part 3: Specification with guidance for the verification and validation of greenhouse gas statements](#), ISO

⁷² [ISO 22095:2020 Chain of custody — General terminology and models](#), ISO

⁷³ Adapted from the definitions in the ISO 14064-3:2019.



Face value (of a token)

GHG emission intensity, expressed as CO₂eq per MJ, carried by each token in addition to the emission category according to GHG-P.

Fungibility

The property of a token that is able to be interchanged with other tokens.

General board

Main governance body comprised of members representing relevant stakeholders from the maritime sector.

Fuel emission intensity

Relative number quantifying the GHG emissions in relation to a specific reference value. The fuel emission intensity stated in CO₂eq per MJ has been chosen the primary face value of the tokens.

GHG emissions

Aggregate of carbon dioxide (CO₂), methane (CH₄) and nitrous oxide (N₂O), converted into carbon dioxide equivalents (CO₂eq) based on their 100-year global warming potential, in line with the FuelEU Maritime provisions.

Level of assurance⁷⁴

Degree of confidence in the data used to generate tokens in the system and the data generated from token transactions.

Non-conformity

The 'non-fulfillment of a requirement.'⁷⁵

Passing

Transfer of fungible tokens downstream a supply chain defined by the specific transport activity.

Reasonable assurance

The level of assurance where the verification activities provide 'a high but not absolute level of assurance on historical data and information.'⁷⁶

Registry

In its simple form, it is a database that stores information about tokens' characteristics (e.g., type of emission scope), status (e.g., fungibility), ownership, and tick marks from transactions (e.g., type of transaction and timestamps).

Segmentation

Partitioning of the market on which tokens can be exchanged in isolated sub-markets depending on certain additional criteria, e.g., vessel or fuel types.

Skipping

A process when an action on tokens upstream a supply chain deprives a participant downstream a supply chain the right to exercise the two-step decision-making process comprising the claiming, swapping, and passing tokens. Upon skipping, on behalf of the skipped participant, the system automatically renders the tokens claimed and immediately passes on the tokens

74 Adapted from ISO 14064-3:2019.

75 [ISO 14064-3:2019 Greenhouse gases — Part 3: Specification with guidance for the verification and validation of greenhouse gas statements](#), ISO

76 [ISO 14064-3:2019 Greenhouse gases — Part 3: Specification with guidance for the verification and validation of greenhouse gas statements](#), ISO



to the next participant downstream a supply chain. Skipping often arises when participants with different roles in the supply chain (e.g., a shipowner swap with a cargo owner) swap tokens.

Status records

Token data that describes essential, additional, and optional information and data required for system functionality, including time stamps, fungibility, and claim status.

Swapping

An exchange of fungible tokens between two participants. During a swap, two parties exchange an equal number of tokens.

Tick mark

Status record representing information about which roles of participants (shipowner, ship operator, freight forwarder, cargo owner) have claimed a token.

Token

A token represents ownership and access rights to data that can be exchanged between participants of the Book & Claim platform. Tokens carry a face value representing CO₂eq per MJ and the corresponding scope 1 or 3 emissions.

Validation

The process of evaluating the procedures, assumptions, and methods used by the system's users to measure emission and voyage-related data as compared to the methodologies and requirements established in the system.⁷⁷

Verification

The process of evaluating the system's data to determine if it complies with the appropriate criteria (as defined above). This process covers both data submitted by the users and the data generated by the system itself (e.g., users' emissions and voyage-related measurements and token ownership and timestamps).⁷⁷

Verifier

Defined as a competent and independent organization that performs the verification activities to assess compliance with the appropriate criteria. The verifier does not have any role or commercial interest in the transportation services that are the object of the verification.⁷⁷

⁷⁷ [ISO 14064-3:2019 Greenhouse gases — Part 3: Specification with guidance for the verification and validation of greenhouse gas statements](#), ISO



Maritime-related definitions

Alternative fuel

Fuels derived from sources other than petroleum; some are derived from renewable sources. Often, they have a lower environmental impact than fossil-based hydrocarbons.

Ballast leg

A leg as a part of a voyage between the last berth/terminal/anchorage of the last port of discharge and the first berth/terminal/anchorage of the first loading port when no cargo or passenger are onboard a vessel. A vessel with no cargo or passenger onboard takes on ballast (usually water) for the safety at sea.

Bareboat charter

Agreement, for the chartering of a vessel, that does not include administration or technical maintenance. The charterer obtains possession and full control of the vessel along with the legal and financial responsibility for it.

Bill of lading

A legally binding document issued by a carrier that authorizes the carrier to transport goods on their behalf.

Cargo owner

In the context of freight transport, a cargo owner is an individual or organization who pays for the transportation of cargo under a legal contract.

Charterparty

Contract between a shipowner and a 'charterer' to hire either a ship for the carriage of passengers or cargo

or a yacht for pleasure purposes. There are three main types of charter parties time, voyage, and bareboat charterparty.

Document of compliance

A safety certificate issued by the flag state to a company which owns ships in compliance with the International Safety Management (ISM) code. One Document of Compliance is issued for one type of vessels (e.g., containers, tankers, bulk carriers) owned by the company.

DOC holder

A company that complies with the requirements of the International Safety Management (ISM) code. Regardless of the charterparties involved by a vessel, the ship has only one DOC and one DOC holder. A DOC holder could be the shipowner who owns the vessel, and sometimes the technical manager to whom the shipowner outsourced the technical management of the vessel.

Freight forwarder

Entity that organizes transportation of goods from one place to another for the cargo owner. A freight forwarder liaises with transport service providers, known as 'carriers'. A freight forwarder does not move the goods, but acts as an agent on behalf of the cargo owners.

Global warming potential

Heat absorbed by any GHG in the atmosphere compared with the heat that would be absorbed by the same mass of carbon dioxide (CO₂). Global warming potential is 1 for CO₂. For other gases, global warming potential depends on the gas and the time frame.

Insetting

Mechanism used to finance GHG emission reduction/avoidance or sequestration in or along its value chain to compensate for the emissions of an organization.



Laden leg

A leg as a part of a voyage when a vessel carries cargo or passengers onboard between berths/terminals/ anchorages of the same port or of different ports.

Leg

The movement between two consecutive berths/ terminals/anchorages for transporting passengers and cargo for a commercial purpose. For the purpose of this paper, movements between berths and anchorages within the same port are also referred to as a leg.

Lower heating value

The lower heating value (also known as net calorific value) of a fuel is defined as the amount of heat released by combusting a specified quantity (initially at 25°C) and returning the temperature of the combustion products to 150°C, which assumes the latent heat of vaporization of water in the reaction products is not recovered.

Offsetting

Mechanism used to finance GHG emission reduction/ avoidance or outside of its value chain to compensate for the emissions of an organization.

Shipowner

Entity who owns a merchant vessel as an asset and equips and exploits the merchant vessel.

Ship operator

Entity that charters vessels from shipowners and sells freight to cargo owners (or freight forwarders, the agents of cargo owners).

Tank-to-wake

Aggregate of all GHG emissions released from the final use of a fuel or energy carrier.

Time charter

Time-bound agreement, for the chartering of a vessel, as opposed to a voyage charter. The owner leases a vessel to a charterer for a fixed period, who is free to sail to any port and transport any cargo, subject to legal regulations. The owner in a time charter is often the shipowner, while the charterer is often the ship operator.

Voyage

Any movement of a ship that originates from or terminates in a port of call that serves the purpose of transporting passengers or cargo for commercial purposes.

Voyage charter

Agreement, for the chartering of a vessel, for transporting a certain type and quantity of cargo from a load port to a port of discharge. The owner in a voyage charter is often the ship operator, while the charterer is often the cargo owner.

Well-to-tank

Aggregate of all GHG emissions released from the production, processing, and delivery of a fuel or energy carrier.

Well-to-wake

Aggregate of all GHG emissions released from the production, processing, delivery, and final use of a fuel or energy carrier.



Annex 1

Table 12: Comparison of IMO's emission-related measures.

	Measures	Description	Scope	Calculation	Units
IMO	Carbon Intensity Indicator (CII)	This is part of the short-term measures of IMO's initial GHG emission strategy. The CII determines the operational carbon intensity of vessels above 5,000 GT. The resulting CII is compared with the required annual CII and rated in five levels from A to E. A indicates superior performance, while E indicates inferior performance. This information should be recorded in the SEEMP. ⁷⁸	CO ₂	CII is calculated as the total CO ₂ emission from the fuel consumed (M) divided by the total transport activity in a calendar year (W). M is calculated by multiplying the annual fuel consumption reported on DCS by a carbon-emission factor associated with the fuel type. On the other hand, W is the actual transport activity. If unavailable, W can be calculated as the supply-based transport activity by multiplying the ship's capacity in DWT or GT by the total distance traveled reported on DCS. ⁷⁹	CII: gCO ₂ /tnm CII Rating: A, B, C, D, or E
	Energy Efficiency Design Index (EEDI)	The EEDI applies to new ships, which must comply with a minimum energy efficiency level using energy-efficient equipment and engines. The minimum level is increased every five years. ⁸⁰ The attained EEDI is calculated by the shipyards and then verified by classification societies.	CO ₂	The EEDI calculates the emissions from fuel combustion, considering the ship's capacity and speed as designed. ⁸¹ The conversion factor and assumptions for each category of ships are defined in Annex 5 of MEPC 73/19/Add.1.	gCO ₂ /tnm
	Energy Efficiency Existing Ship Index (EEXI)	This is also part of the short-term measures of IMO's initial GHG emission strategy. The attained EEXI indicates the ships' energy efficiency compared with a required EEXI. ⁸² Ships above 400 GT are required to comply with it.	CO ₂	The index calculates the CO ₂ emission per transport activity related to the installed main engine and auxiliary engine. This follows the parameters of the EEDI and is adjusted for existing ships. It is important to clarify that this is not an operational index. Instead, it calculates the values based on information from the engine test bed, fuel emission factors, and the transport activity is determined by capacity. ⁸³	gCO ₂ /tnm
	Energy Efficiency Operational Indicator (EEOI)	The EEOI is a voluntary measure of operational performance, which allows users to calculate the emissions generated per unit of transport activity, which may vary depending on the segment (tonne, TEU, etc.). ⁸⁴	CO ₂	The EEOI is calculated by dividing the total emission from the fuel consumed by the transport activity.	tCO ₂ /tnm

78 [Carbon Intensity Indicator](#), Lloyd's Register

79 [IMO's MEPC 78/17/Add.1, Annex 14](#), International Maritime Organization

80 [Energy Efficiency Measures](#), International Maritime Organization

81 [IMO's MEPC 73/19/Add.1, Annex 5](#), International Maritime Organization

82 [EEXI and CII - ship carbon intensity and rating system](#), International Maritime Organization

83 [EEXI - Energy Efficiency Existing Ship Index](#), DNV

84 [Energy Efficiency Measures](#), International Maritime Organization



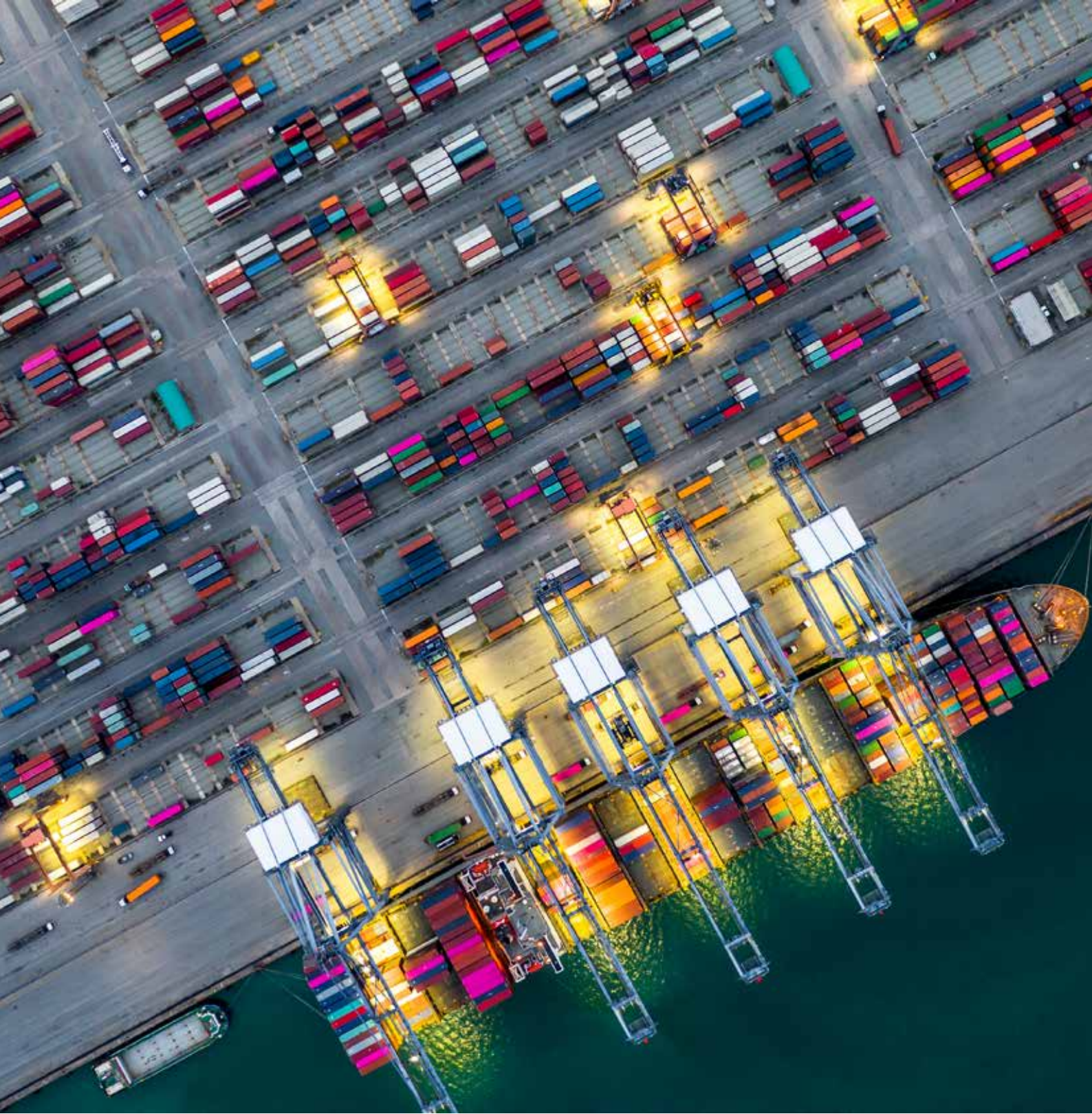

Visit our website for more
[zerocarbonshipping.com](https://www.zerocarbonshipping.com)



Mærsk Mc-Kinney Møller Center
for Zero Carbon Shipping